



2019 CATALOGUE

MODERN FASHION

High quality professional commercial led lighting



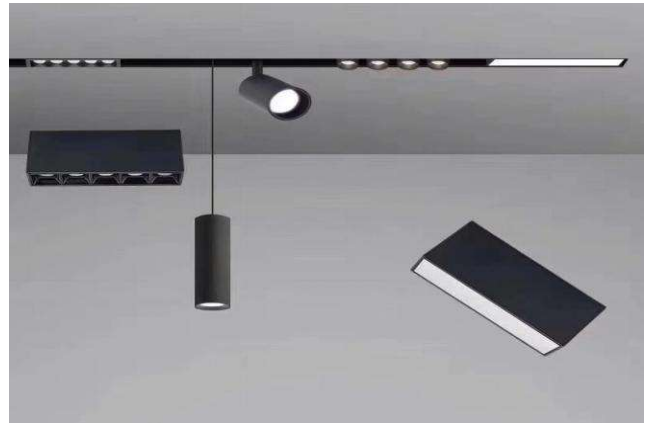

1.trimless 2.surface mounted 3.hanging



L-300 15W L-600 30W



CX20 20W 276*35mm



WS-15 15W 276*35mm



CL10 10W 136*100*35mm



CL20 20W 270*100*35mm



H2030 30W 137*37*220mm



X006 6W ϕ 36*66mm



X012 12W ϕ 60*80mm



X025 25W ϕ 80*100mm



HG01 6W Φ 100mm



HG02 6W Φ 120mm



HG03 12W Φ 30*300mm



Finishing Color

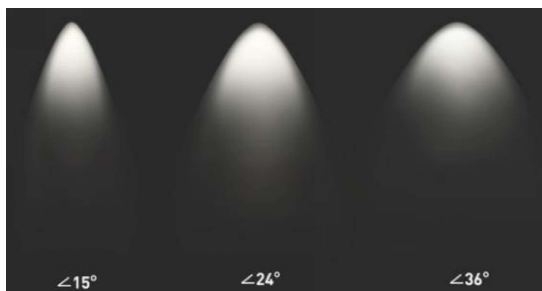
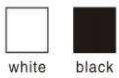

Model Code	JD012	JD027
Power	12W	27W
Size:	120*53*180mm	160*53*180mm
Cut out	Track	Track
Light Source	CREE XPE	CREE XPE
Optical	Lens	Lens

UGR	<25	<25
Flicker	√	√
Beam angle	12° / 15° / 25° / 55° / 75° 35°35° / 35°75° / 55°55° / 75°75°	

CCT	3000K/4000K/6000K	
Lumens	960lm	2160lm
Power Factor	0.95	0.95
Efficiency	80%	80%
Lifespan	50000h	50000h
Input Voltage	AC85-265V	
IP	20	20
Driver	Lifud	Lifud
Material	Alu	Alu

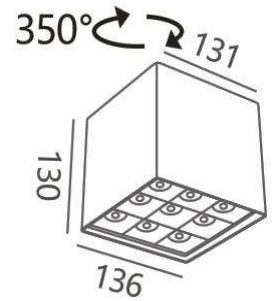
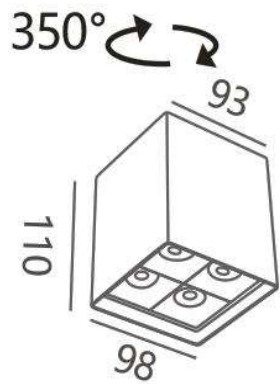

Model Code	G4X5	G9X3
Power	20W	27W
Size:	98*93*110mm	136*131*130mm
Cut out	Surface mounted	Surface mounted
Light Source	CREE	CREE
Optical	Reflector	Reflector
UGR	<25	<25
Fliker<15%	√	√
Beam angle	12° / 15° / 25° / 55° / 75° / 35*35° / 35*75° / 55*55° / 75*75°	12° / 15° / 25° / 55° / 75° / 35*35° / 35*75° / 55*55° / 75*75°
CCT	2700-6500K	2700-6500K
Power Factor	0.95	0.95
Efficiency	80%	80%
Input Voltage	AC85-265V	AC85-265V
Driver	Eaglerise /Lifud	Eaglerise /Lifud
IP	20	20
Material	Aluminium	Aluminium
Lifespan	50000h	50000h

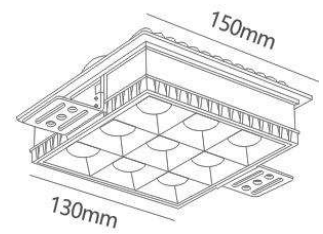
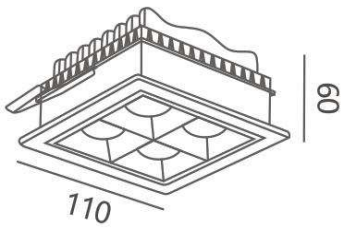

Model Code	R4X5	R9X3
Power	20W	27W
Size:	110*60mm	150*130*60mm
Cut out	95*95mm	150*130mm
Light Source	CREE	CREE
Optical	Reflector	Reflector
UGR	<25	<25
Fliker<15%	√	√
Beam angle	12° / 15° / 25° / 55° / 75° / 35*35° / 35*75° / 55*55° / 75*75°	12° / 15° / 25° / 55° / 75° / 35*35° / 35*75° / 55*55° / 75*75°
CCT	2700-6500K	2700-6500K
Power Factor	0.95	0.95
Efficiency	80%	80%
Input Voltage	AC85-265V	AC85-265V
Driver	Eaglerise /Lifud	Eaglerise /Lifud
IP	20	20
Material	Aluminium	Aluminium
Lifespan	50000h	50000h

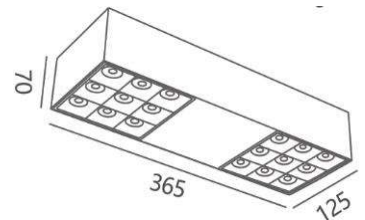

Model Code	H932
Power	54W
Size:	365*125mm
Cut out	Surface mounted
Light Source	CREE
Optical	Reflector
UGR	<25
Fliker<15%	√
Beam angle	12° / 15° / 25° / 55° / 75° / 35*35° / 35*75° / 55*55° / 75*75°
CCT	2700-6500K
Power Factor	0.95
Efficiency	80%
Input Voltage	AC85-265V
Driver	Eaglerise /Lifud
IP	20
Material	Aluminium
Lifespan	50000h

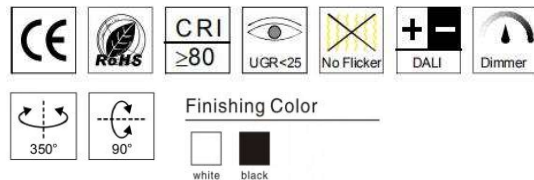

Model Code	JD009	JD015
Power	9W	15W
Size:	118*145mm	193*145mm
Cut out	Track	Track
Light Source	CREE XPE	CREE XPE
Optical	Lens	Lens

UGR	<25	<25
Flicker	<15%	<15%
Beam angle	15°/24°/36°	15°/24°/40°

CCT	3000K/4000K/6000K
Lumens	480lm / 960lm
Power Factor	0.95
Efficiency	80%
Lifespan	50000h
Input Voltage	AC85-265V
IP	20
Driver	Lifud
Material	Alu

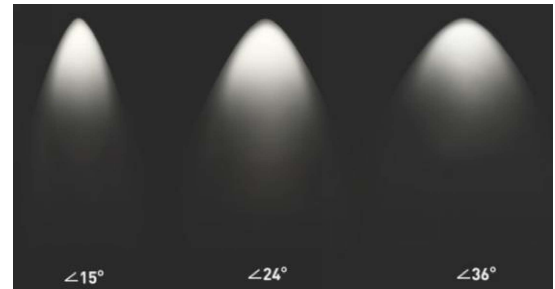
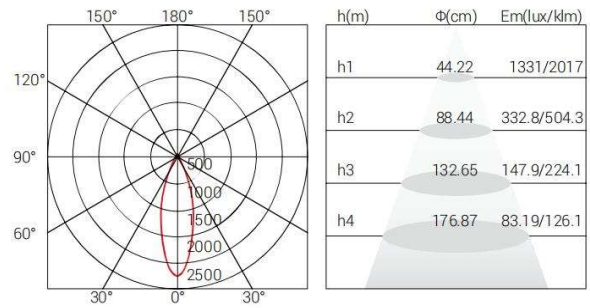

Finishing Color

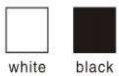

Model Code	TR606	TR612
Power	6W	12W
Size:	62*26*204mm	116*26*133mm
Cut out	Track	Track
Light Source	CREE XPE	CREE XPE
Optical	Lens	Lens

UGR	<25	<25
Fliker<15%	√	√
Beam angle	15°24°/36°	15°24°/40°

CCT	3000K/4000K/6000K	
Lumens	480lm	960lm
Power Factor	0.95	0.95
Efficiency	80%	80%
Lifespan	50000h	50000h
Input Voltage	AC85-265V	AC85-265V
IP	20	20
Driver	Lifud	Lifud
Material	Alu	Alu

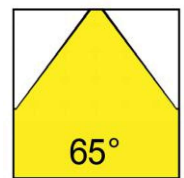
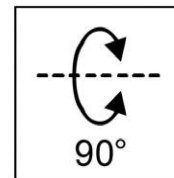
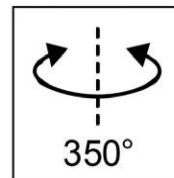
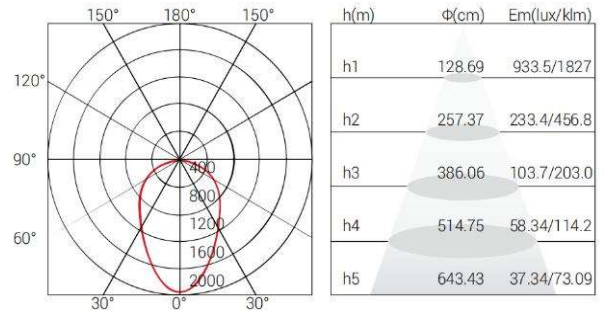

Finishing Color

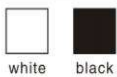

Model Code	TR830
Power	30W
Size:	155*40*180mm
Cut out	Track
Light Source	CREE XPE / OSRAM 3030
Optical	Lens

UGR	<25
Fliker<15%	√
Beam angle	65°

CCT	3000K/4000K/6000K
Lumens	2400lm
Power Factor	0.95
Efficiency	80%
Lifespan	50000h
Input Voltage	AC85-265V
IP	20
Driver	Lifud
Material	Alu



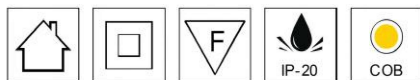
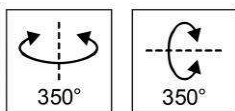
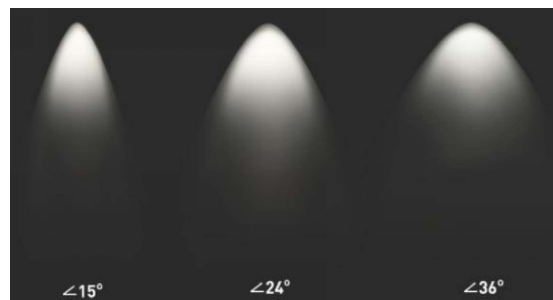
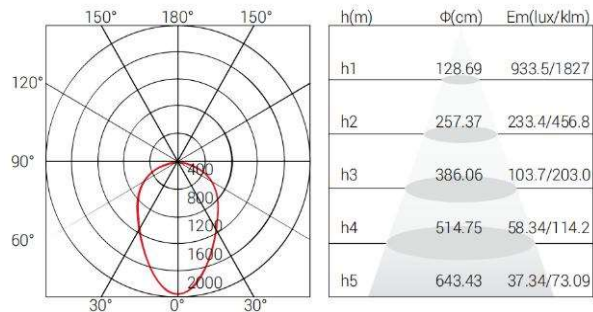

Finishing Color

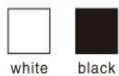

Model Code	TP-739
Power	18W
Size:	Φ70*H250mm
Cut out	by Track and Surface Mounted
Light Source	Luminus / CREE
Optical	Lens

UGR	<19
Fliker<15%	√
Beam angle	15°/24°/36°

CCT	3000K/4000K/6000K
Lumens	1450lm
Power Factor	0.95
Efficiency	80%
Lifespan	50000h
Input Voltage	AC85-265V
IP	20
Driver	Lifud
Material	Aluminum

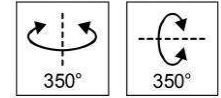

Finishing Color

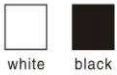

Model Code	TP788	UGR	<16	Input Voltage	AC85-265V
Power	15W	Fliker	<15%	Driver	Eaglerise / Philips
Size:	60*60*180mm	Beam angle	18°/ 24°/ 36°	IP	20
Cut out	Led track and Surface mounted	CCT	3000K/4000K/6000K	Material	Aluminium
Light Source	Luminus / CREE	Power Factor	0.95	Lifespan	50000h
Optical	Lens	Efficiency	80%		



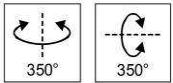

Finishing Color

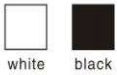

Model Code	CL15 / CL20 / CL30	UGR	< 22	Input Voltage	AC85-265V
Power	15W / 20W / 30W	Fliker<15%	√	Driver	Eaglerise / Philips
Size:	Φ85*52 / Φ102*64 / Φ122*75 mm	Beam angle	12° / 24° / 40° / 60°	IP	20
Cut out	Led track and recessed	CCT	3000K/4000K/6000K	Material	Aluminium
Light Source	Luminus / CREE	Power Factor	0.95	Lifespan	50000h
Optical	Lens	Efficiency	80%		

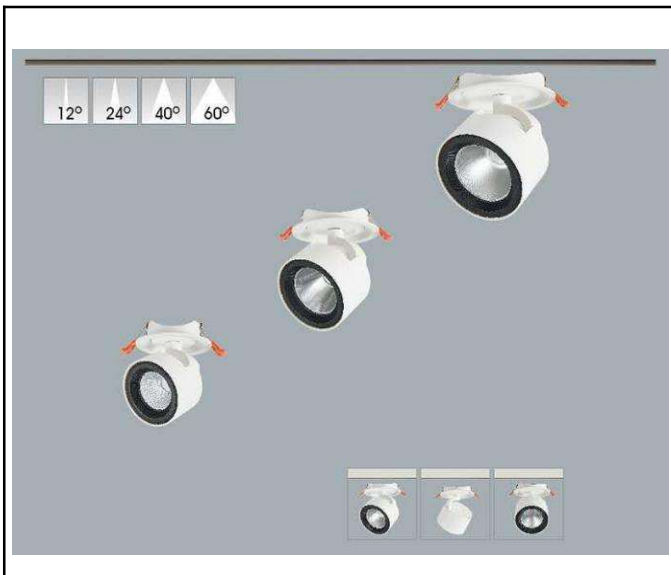

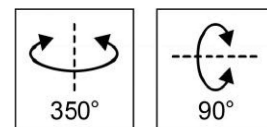

Finishing Color

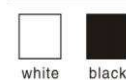

Model Code	ZH-H12S	UGR	<19	Input Voltage	AC85-265V
Power	12W	Fliker	<15%	Driver	Eaglerise / Philips
Size:	100*H100mm	Beam angle	18°/ 24°/ 36°	IP	20
Cut out	Led track and Surface mounted	CCT	3000K/4000K/6000K	Material	Aluminium
Light Source	Luminus / CREE	Power Factor	0.95	Lifespan	50000h
Optical	Lens	Efficiency	80%		

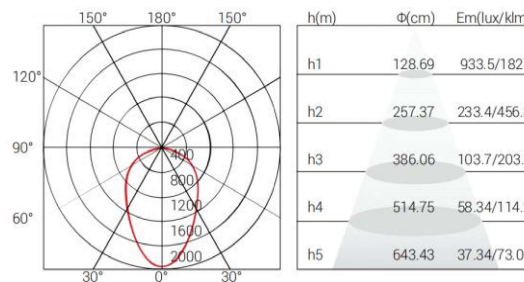
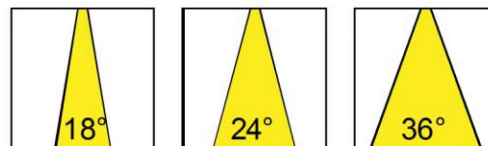
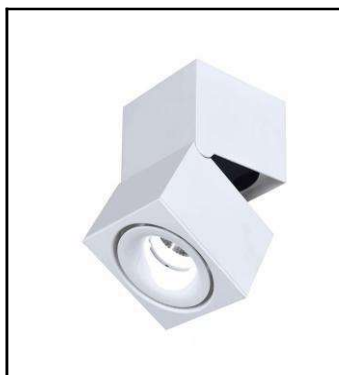

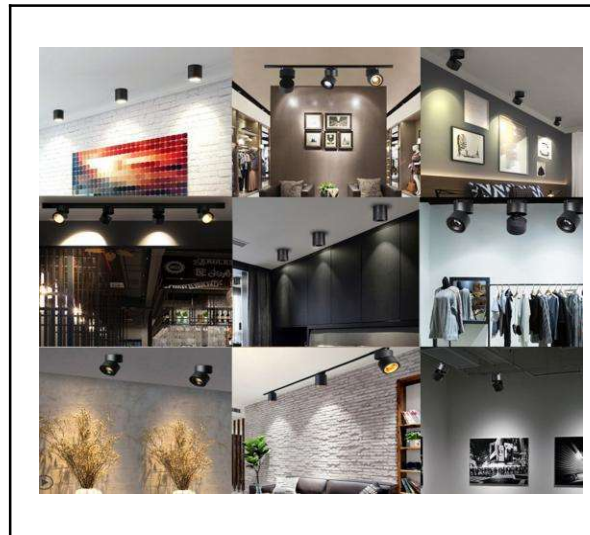

Finishing Color

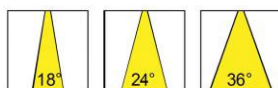
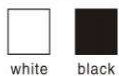

Model Code	ZH-H12	UGR	<19	Input Voltage	AC85-265V
Power	12W	Fliker	<15%	Driver	Eaglerise / Philips
Size:	Φ100*H100mm	Beam angle	18° / 24° / 36°	IP	20
Cut out	Led track and Surface mounted	CCT	3000K/4000K/6000K	Material	Aluminium
Light Source	Luminus / CREE	Power Factor	0.95	Lifespan	50000h
Optical	Lens	Efficiency	80%		

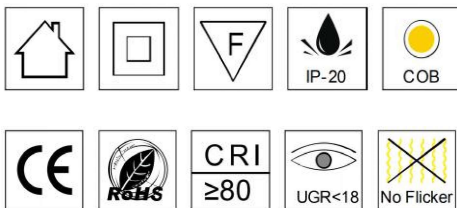
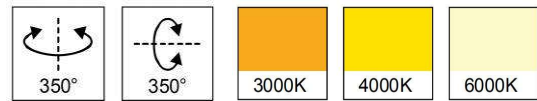
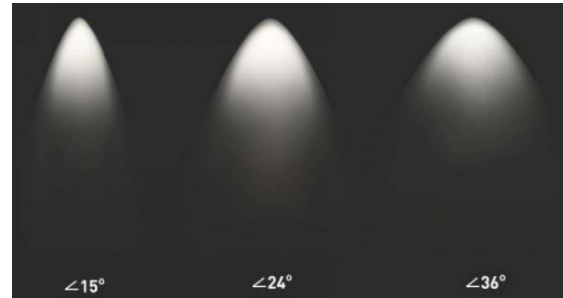
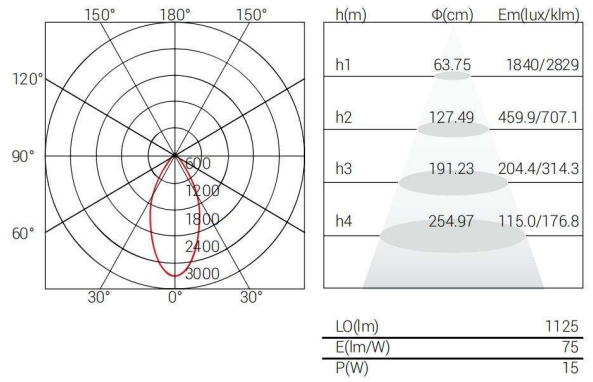

Finishing Color

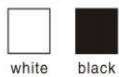

Model Code	ZK-802
Power	14W
Size:	Φ47*140*125mm
Cut out	Track
Light Source	Luminus / CREE
Optical	Lens

UGR	<18
Flicker<15%	√
Beam angle	18° / 24° / 36°

CCT	3000K/4000K/6000K
Lumens	1125lm
Power Factor	0.95
Efficiency	80%
Lifespan	50000h
Input Voltage	AC85-265V
IP	20
Driver	
Material	Aluminium



Model Code	ZH-805B	UGR	<19	Input Voltage	AC85-265V
Power	7W	Flicker	<15%	Driver	Eaglerise / Philips
Size:	Φ55*280mm	Beam angle	18° / 24° / 36°	IP	20
Cut out	Led track and Surface mounted	CCT	3000K/4000K/6000K	Material	Aluminium
Light Source	Luminus / CREE	Power Factor	0.95	Lifespan	50000h
Optical	Lens	Efficiency	80%		

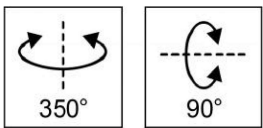

Finishing Color

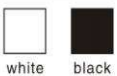



Dimmable

**Beam Angle Adjustable 10~70°
25 W**

Model Code	T-A825	UGR	<25	Input Voltage	AC85-265V
Power	25W	Fliker<15%	√	Driver	Dimmable
Size:	Φ55*280mm	Beam angle	10°-70°	IP	20
Cut out	Led track	CCT	3000K/4000K/6000K	Material	Aluminium
Light Source	Luminus / CREE	Power Factor	0.95	Lifespan	50000h
Optical	Lens	Efficiency	80%		



Finishing Color

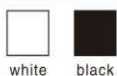



Model Code	TP-B835	UGR	<25	Input Voltage	AC85-265V
Power	30W	Fliker<15%	√	Driver	Dimmable
Size:	Φ90*H216mm	Beam angle	10°-70°	IP	20
Cut out	Led track	CCT	3000K/4000K/6000K	Material	Aluminium
Light Source	Luminus / CREE	Power Factor	0.95	Lifespan	50000h
Optical	Lens	Efficiency	80%		

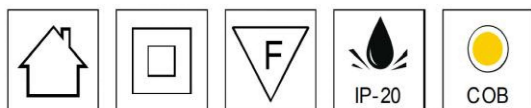

Finishing Color

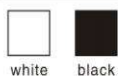



- Patentable structure design: suitable for somewhere ceiling is made by cement your ceiling inner is narrow for a lamp.
- Anti-glare Design: Utilize the black light technology to restrain effectively the glare for improving the satisfaction of lighting environment.
- Neutral cylindrical shape design made by aluminum show a natural and understated luxury appearance.
- Well Adaption: Surface Mounted Led Downlight with high Brightness easier to make integration with ambient environment

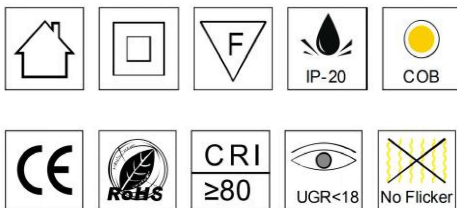
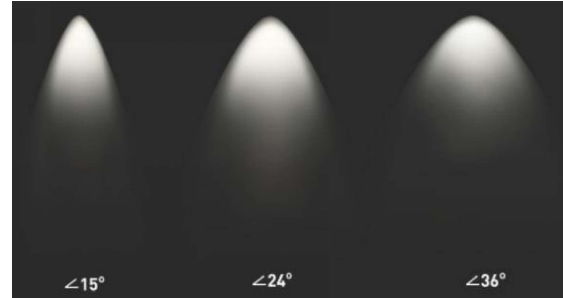
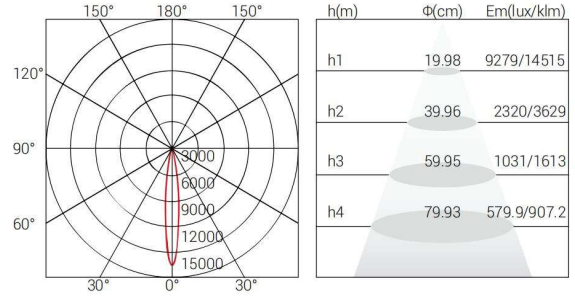

Finishing Color

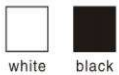

Model Code	ZT-807 / ZT-810 / ZT-815
Power	7W / 10W / 15W
Size:	Φ60*H200mm / H300mm / H600mm
Cut out	Surface Mounted and Hanging
Light Source	Luminus / CREE
Optical	Lens

UGR	<18
Flicker<15%	√
Beam angle	18° / 24° / 36°

CCT	3000K/4000K/6000K
Lumens	560lm /800lm /1200lm
Power Factor	0.95
Efficiency	80%
Lifespan	50000h
Input Voltage	AC85-265V
IP	20
Driver	Eaglerise / Philips / Lifud
Material	Aluminium

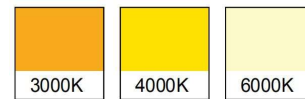
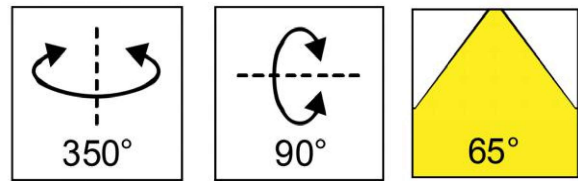
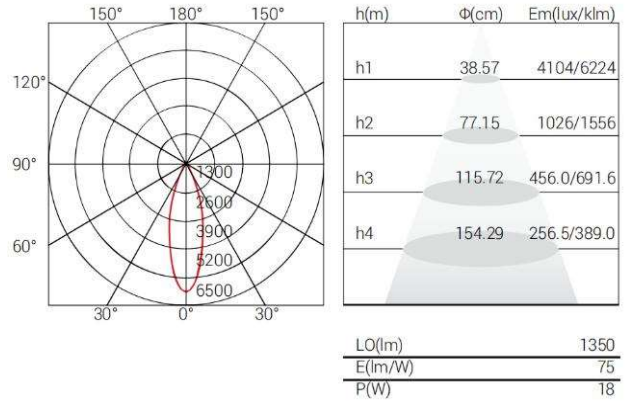

Finishing Color

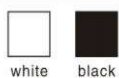

Model Code	PH-07 / PH-12 / PH-18
Power	7W / 12W / 18W
Size:	ΦΦ60*H200mm / H300mm / H600mm
Cut out	Surface Mounted and Hanging
Light Source	Luminus / CREE
Optical	Lens

UGR	<25
Fliker<15%	√
Beam angle	45° / 65°

CCT	3000K/4000K/6000K
Lumens	560lm /960lm /1450lm
Power Factor	0.95
Efficiency	80%
Lifespan	50000h
Input Voltage	AC85-265V
IP	20
Driver	Eaglerise / Philips / Lifud
Material	Aluminium

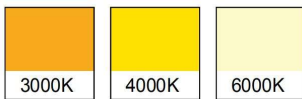
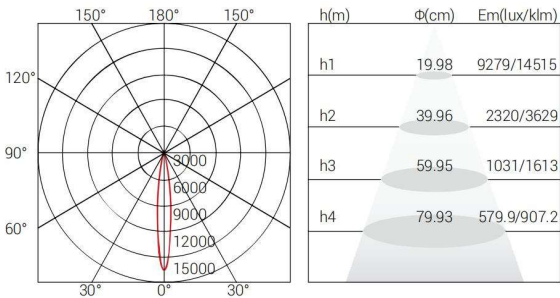

Finishing Color

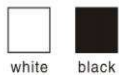

Model Code	S-508
Power	7W
Size:	75*75*100
Cut out	Surface Mounted
Light Source	Luminus / CREE
Optical	Lens

UGR	<25
Fliker<15%	√
Beam angle	15° / 24° / 36°

CCT	3000K/4000K/6000K
Lumens	560lm
Power Factor	0.95
Efficiency	80%
Lifespan	50000h
Input Voltage	AC85-265V
IP	20
Driver	Eaglerise / Philips / Lifud
Material	Aluminium

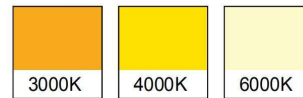
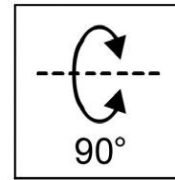
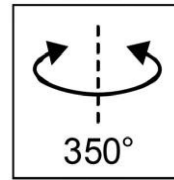
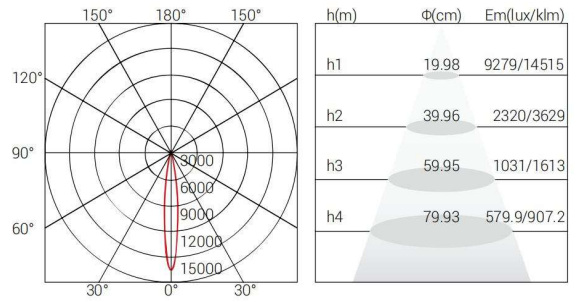

Model Code	JH001
Power	6W
Size:	117*26*90mm
Cut out	Surface Mounted
Light Source	Luminus / CREE
Optical	Lens

UGR	<25
Flicker	<15%
Beam angle	15°/24°/45°

CCT	3000K/4000K/6000K
Lumens	480lm
Power Factor	0.95
Efficiency	80%
Lifespan	50000h
Input Voltage	AC85-265V
IP	20
Driver	CE DRIVER
Material	Aluminium

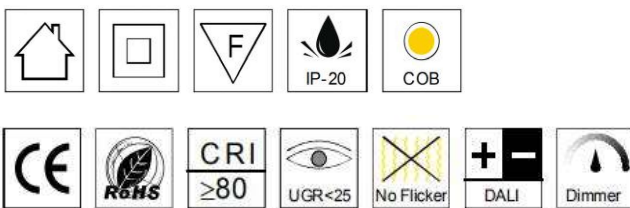

Finishing Color

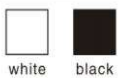

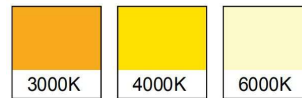
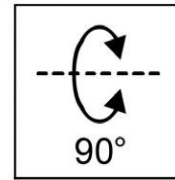
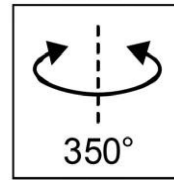
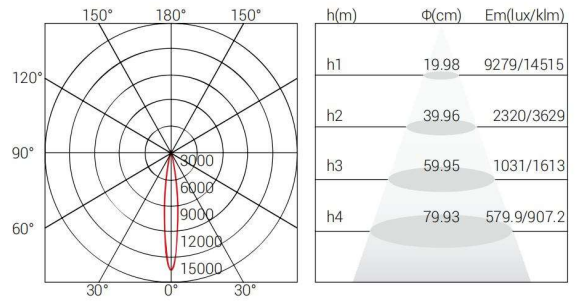

Model Code	T-368
Power	12W
Size:	Φ100*60mm
Cut out	Surface Mounted
Light Source	Luminus / CREE
Optical	Lens

UGR	<25
Flicker	<15%
Beam angle	45° / 65°

CCT	3000K/4000K/6000K
Lumens	560lm /960lm /1450lm
Power Factor	0.95
Efficiency	80%
Lifespan	50000h
Input Voltage	AC85-265V
IP	20
Driver	Eaglerise / Philips / Lifud
Material	Aluminium

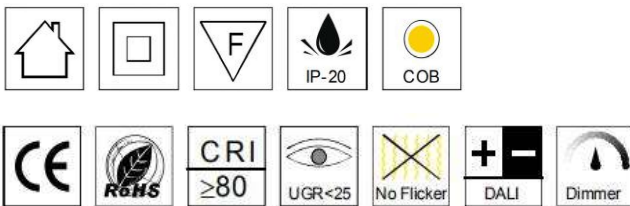

Finishing Color

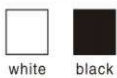

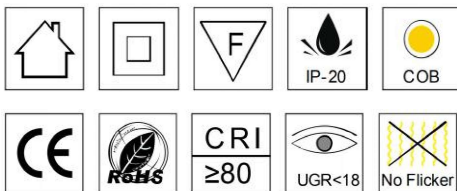
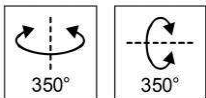
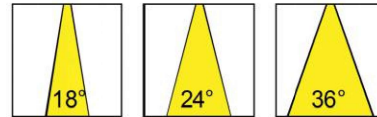
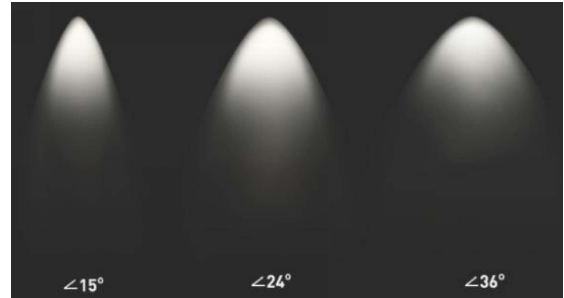
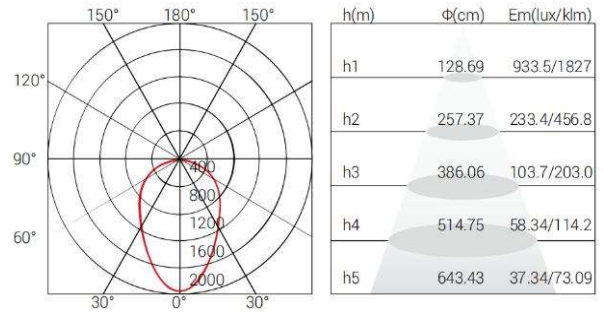

Finishing Color

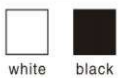

Model Code	TP-786
Power	15W
Size:	60*60*H180mm
Cut out	Surface Mounted
Light Source	Luminus / CREE
Optical	Lens

UGR	<18
Flicker	<15%
Beam angle	18° / 24° / 36°

CCT	3000K/4000K/6000K
Lumens	1200lm
Power Factor	0.95
Efficiency	80%
Lifespan	50000h
Input Voltage	AC85-265V
IP	20
Driver	Eaglerise / Philips / Lifud
Material	Aluminium

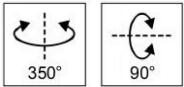
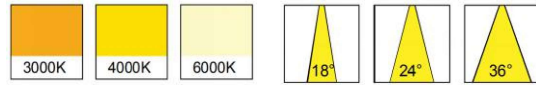
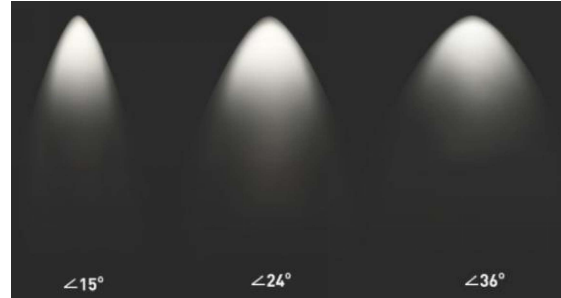
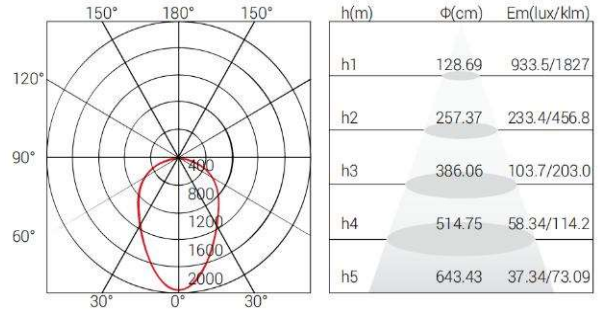

Finishing Color

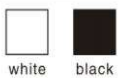

Model Code	T-365
Power	12W
Size:	Φ100*60mm
Cut out	Surface Mounted
Light Source	Luminus / CREE
Optical	Lens

UGR	<18
Flicker	<15%
Beam angle	45° / 65°

CCT	3000K/4000K/6000K
Lumens	560lm /960lm /1450lm
Power Factor	0.95
Efficiency	80%
Lifespan	50000h
Input Voltage	AC85-265V
IP	20
Driver	Eaglerise / Philips / Lifud
Material	Aluminium

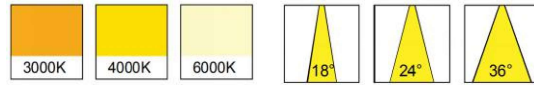
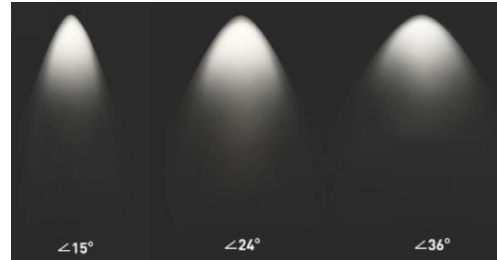
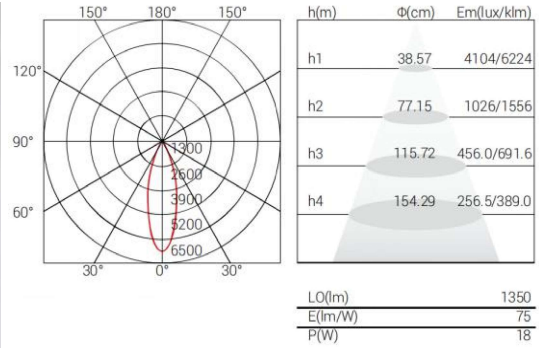

Model Code	TP-715
Power	20W
Size:	Φ68*H188mm
Cut out	Surface Mounted
Light Source	Luminus / CREE
Optical	Lens

UGR	<25
Fliker<15%	√
Beam angle	18° / 24° / 36°

CCT	3000K/4000K/6000K
Lumens	1600lm
Power Factor	0.95
Efficiency	80%
Lifespan	50000h
Input Voltage	AC85-265V
IP	20
Driver	Eaglerise / Philips / Lifud
Material	Aluminium

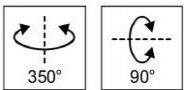

Finishing Color

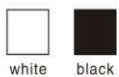



Model Code	TP-718	UGR	<19	Input Voltage	AC85-265V
Power	18W	Flicker	<15%	Driver	Eaglerise / Philips
Size:	Φ70*305mm	Beam angle	18°/ 24°/ 36°	IP	20
Cut out	Surface mounted	CCT	3000K/4000K/6000K	Material	Aluminium
Light Source	Luminus / CREE	Power Factor	0.95	Lifespan	50000h
Optical	Lens	Efficiency	80%		

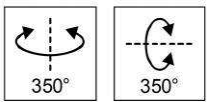

Finishing Color

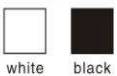

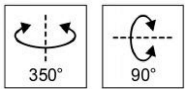
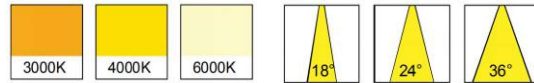
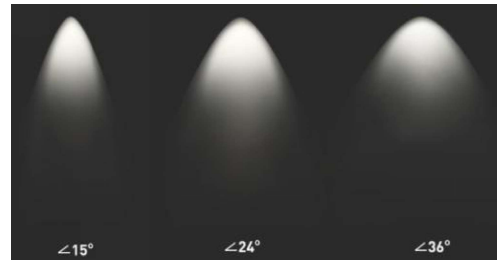
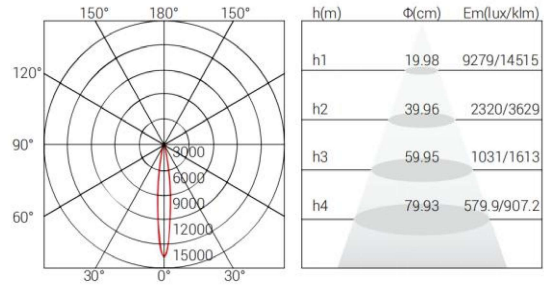

Finishing Color

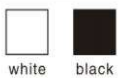

Model Code	HP812
Power	7W
Size:	Φ48*150mm
Cut out	Surface Mounted
Light Source	Luminus / CREE
Optical	Lens

UGR	<18
Flicker<15%	√
Beam angle	18° / 24° / 36°

CCT	3000K/4000K/6000K
Lumens	560lm
Power Factor	0.95
Efficiency	80%
Lifespan	50000h
Input Voltage	AC85-265V
IP	20
Driver	Eaglerise / Philips / Lifud
Material	Aluminium

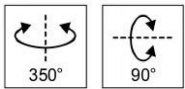
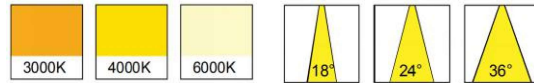
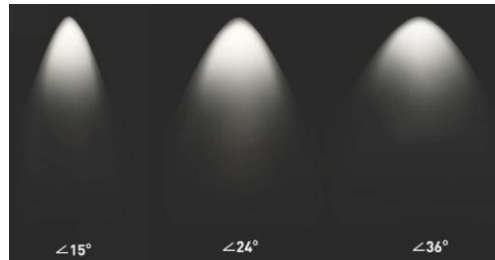
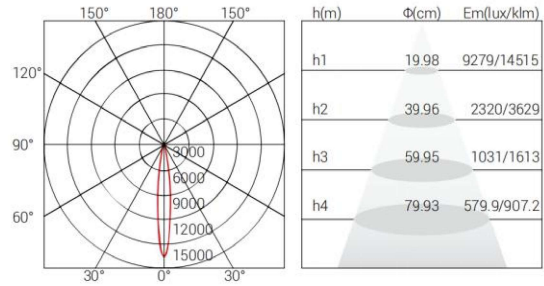

Finishing Color

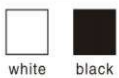

Model Code	T-12B
Power	12W
Size:	Φ63*H155mm
Cut out	Surface Mounted
Light Source	Luminus / CREE
Optical	Lens

UGR	<18
Fliker<15%	√
Beam angle	18° / 24° / 36°

CCT	3000K/4000K/6000K
Lumens	960lm
Power Factor	0.95
Efficiency	80%
Lifespan	50000h
Input Voltage	AC85-265V
IP	20
Driver	Eaglerise / Philips / Lifud
Material	Aluminium

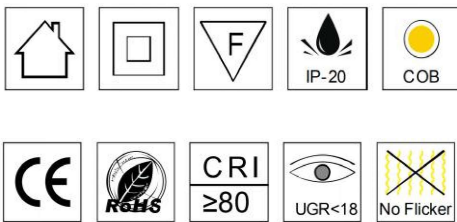
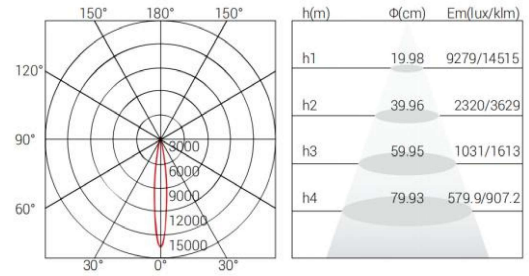

Finishing Color

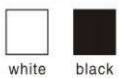

Model Code	ZH-809
Power	7W
Size:	Φ38*280mm
Cut out	Surface Mounted
Light Source	Luminus / CREE
Optical	Lens

UGR	<18
Flicker	<15%
Beam angle	15°

CCT	3000K/4000K/6000K
Lumens	560lm
Power Factor	0.95
Efficiency	80%
Lifespan	50000h
Input Voltage	AC85-265V
IP	20
Driver	Eaglerise / Philips / Lifud
Material	Aluminium



Finishing Color

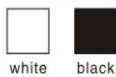

Model Code	F1009	UGR	<19	Input Voltage	AC85-265V
Power	9W	Fliker	<15%	Driver	Eaglerise
Size:	Φ54*H142mm	Beam angle	18°/ 24°/ 36°	IP	20
Cut out	Surface mounted	CCT	3000K/4000K/6000K	Material	Aluminium
Light Source	Luminus / CREE	Power Factor	0.95	Lifespan	50000h
Optical	Lens	Efficiency	80%		

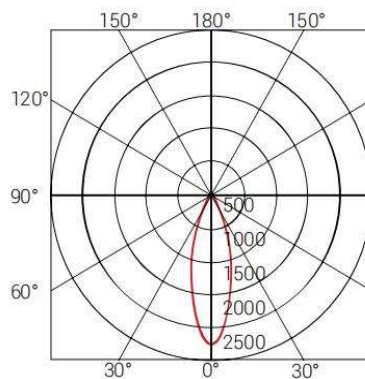

h(m)	Φ(cm)	Em(lux/klm)
h1	43.39	1347/2061
h2	86.79	336.7/515.4
h3	130.18	149.6/229.0
h4	173.58	84.17/128.8
h5	216.97	53.87/82.46



Finishing Color

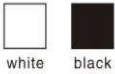

Model Code	V-007 / V-012	UGR	<19	Input Voltage	AC85-265V
Power	7W / 12W	Fliker	<15%	Driver	Lifud
Size:	Φ58*H100mm / Φ75*H100mm	Beam angle	18° / 24° / 36°	IP	20
Cut out	Surface mounted	CCT	3000K/4000K/6000K	Material	Aluminium
Light Source	Luminus / CREE	Power Factor	0.95	Lifespan	50000h
Optical	Lens	Efficiency	80%		

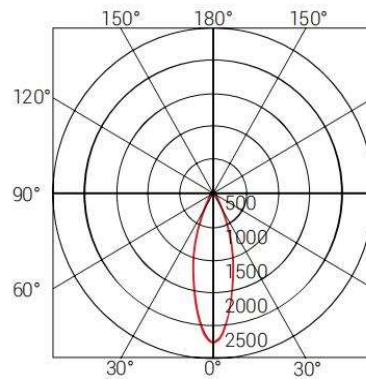

h(m)	Φ(cm)	Em(lux/klm)
h1	43.39	1347/2061
h2	86.79	336.7/515.4
h3	130.18	149.6/229.0
h4	173.58	84.17/128.8
h5	216.97	53.87/82.46



Finishing Color

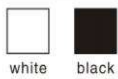

Model Code	F1015	UGR	<19	Input Voltage	AC85-265V
Power	15W	Fliker	<15%	Driver	Eaglerise / Philips
Size:	Φ67*H155mm	Beam angle	18°/ 24°/ 36°	IP	20
Cut out	Surface mounted	CCT	3000K/4000K/6000K	Material	Aluminium
Light Source	Luminus / CREE	Power Factor	0.95	Lifespan	50000h
Optical	Lens	Efficiency	80%		

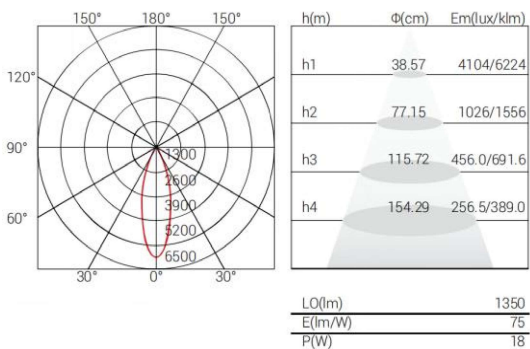



Finishing Color

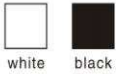

Model Code	E1007	UGR	<19	Input Voltage	AC85-265V
Power	7W	Flicker	<15%	Driver	Eaglerise
Size:	Φ54*H120mm	Beam angle	18°/ 24°/ 36°	IP	20
Cut out	Surface mounted	CCT	3000K/4000K/6000K	Material	Aluminium
Light Source	Luminus / CREE	Power Factor	0.95	Lifespan	50000h
Optical	Lens	Efficiency	80%		

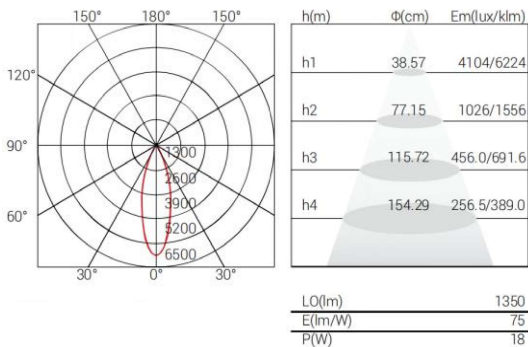

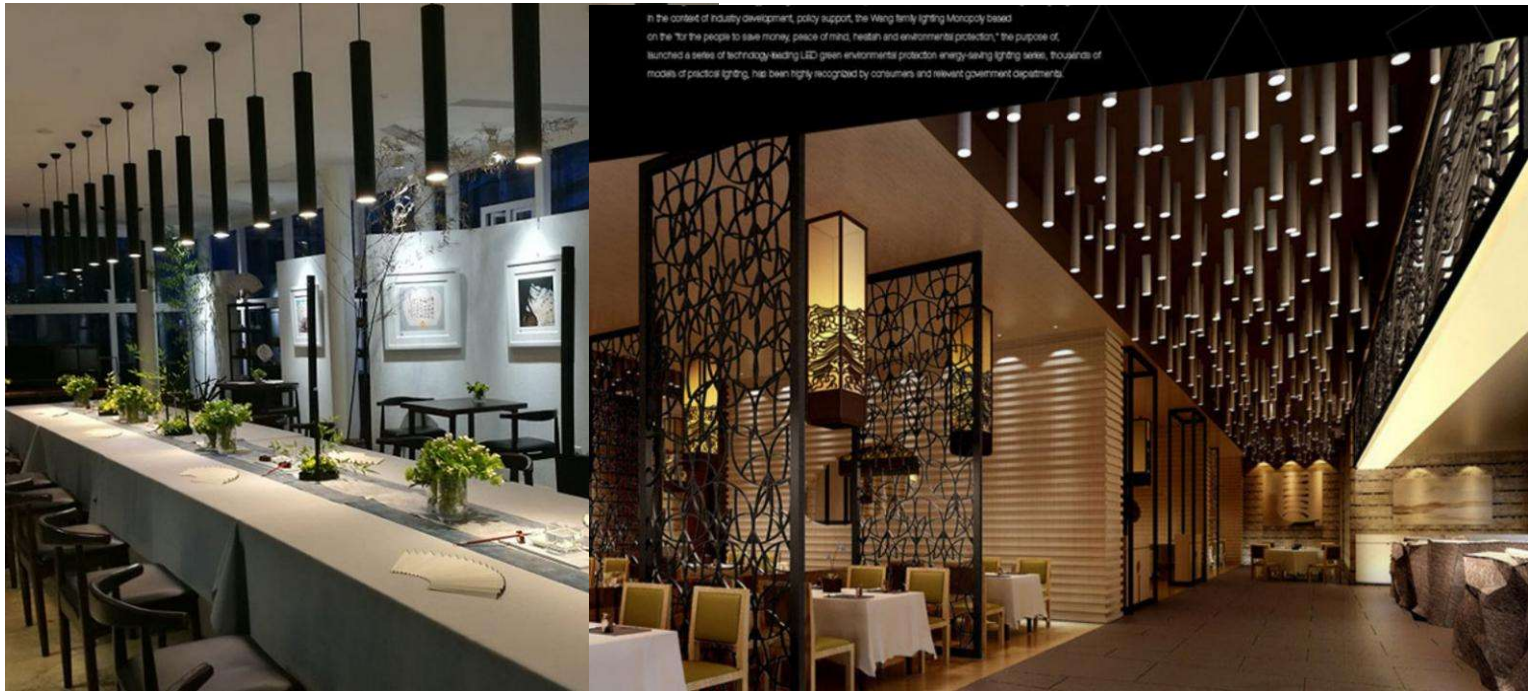

In the context of industry development, policy support, the Wang family lighting Monopoly based on the "for the people to save money, peace of mind, health and environmental protection," the purpose of, launched a series of technology-leading LED green environmental protection energy-saving lighting series, thousands of models of practical lighting, has been highly recognized by consumers and relevant government departments.

Model Code	E1007	UGR	<19	Input Voltage	AC85-265V
Power	7W	Fliker	<15%	Driver	Eaglerise
Size:	Φ54*H120mm	Beam angle	18°/ 24°/ 36°	IP	20
Cut out	Surface mounted and hanging	CCT	3000K/4000K/6000K	Material	Aluminium
Light Source	Luminus / CREE	Power Factor	0.95	Lifespan	50000h
Optical	Lens	Efficiency	80%		



Finishing Color

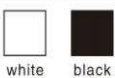



Finishing Color

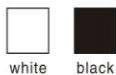

Model Code	S10 / S20	UGR	<22	Input Voltage	AC85-265V
Power	10W / 20W	Fliker<15%	√	Driver	Eaglerise
Size:	80*80*H85mm / 155*80*85mm	Beam angle	18° / 24° / 36°	IP	20
Cut out	Surface mounted	CCT	3000K/4000K/6000K	Material	Aluminium
Light Source	Luminus / CREE	Power Factor	0.95	Lifespan	50000h
Optical	Lens	Efficiency	80%		



3000K



4000K



Finishing Color

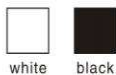

Model Code	L07 / L14 / L21	UGR	<25	Input Voltage	AC85-265V
Power	7W / 7*2W / 7*3W	Fliker	<15%	Driver	Eaglerise
Size:	100*100/200*100/285*100*H120mm	Beam angle	18° / 24° / 36°	IP	20
Cut out	Surface mounted	CCT	3000K/4000K/6000K	Material	Aluminium
Light Source	Luminus / CREE	Power Factor	0.95	Lifespan	50000h
Optical	Lens	Efficiency	80%		

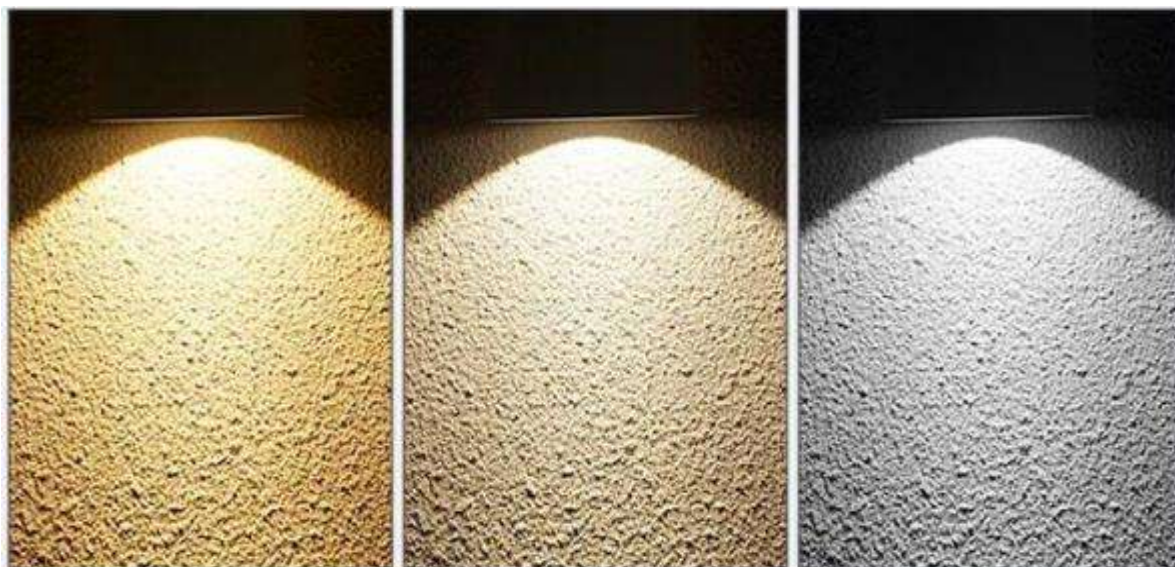



Model Code	RL10	RL15	RL20	RL30
Power	10W	15W	20W	30W
Size:	Φ117*H115mm	Φ138*H115mm	Φ170*H140mm	Φ200*H140mm
Cut out	Surface mounted	Surface mounted	Surface mounted	Surface mounted
Light Source	Luminus / CREE	Luminus / CREE	Luminus / CREE	Luminus / CREE
Optical	Reflector	Reflector	Reflector	Reflector
UGR	<25	<25	<25	<25
Fliker<15%	√	√	√	√
Beam angle	40°	40°	40°	40°
CCT	3000K/4000K/6000K			
Power Factor	0.95	0.95	0.95	0.95
Efficiency	80%	80%	80%	80%
Input Voltage	AC85-265V	AC85-265V	AC85-265V	AC85-265V
Driver	Eaglerise /Lifud	Eaglerise /Lifud	Eaglerise /Lifud	Eaglerise /Lifud
IP	20	20	20	20
Material	Aluminium	Aluminium	Aluminium	Aluminium
Lifespan	50000h	50000h	50000h	50000h



Model Code	SL10	SL15	SL20	SL30
Power	10W	15W	20W	30W
Size:	80*80*H103mm	100*100*H112mm	120*120*H133mm	150*150*H142mm
Cut out	Surface mounted	Surface mounted	Surface mounted	Surface mounted
Light Source	Luminus / CREE	Luminus / CREE	Luminus / CREE	Luminus / CREE
Optical	Reflector	Reflector	Reflector	Reflector
UGR	<25	<25	<25	<25
Fliker<15%	√	√	√	√
Beam angle	40°	40°	40°	40°
CCT	3000K/4000K/6000K			
Power Factor	0.95	0.95	0.95	0.95
Efficiency	80%	80%	80%	80%
Input Voltage	AC85-265V	AC85-265V	AC85-265V	AC85-265V
Driver	Eaglerise /Lifud	Eaglerise /Lifud	Eaglerise /Lifud	Eaglerise /Lifud
IP	20	20	20	20
Material	Aluminium	Aluminium	Aluminium	Aluminium
Lifespan	50000h	50000h	50000h	50000h

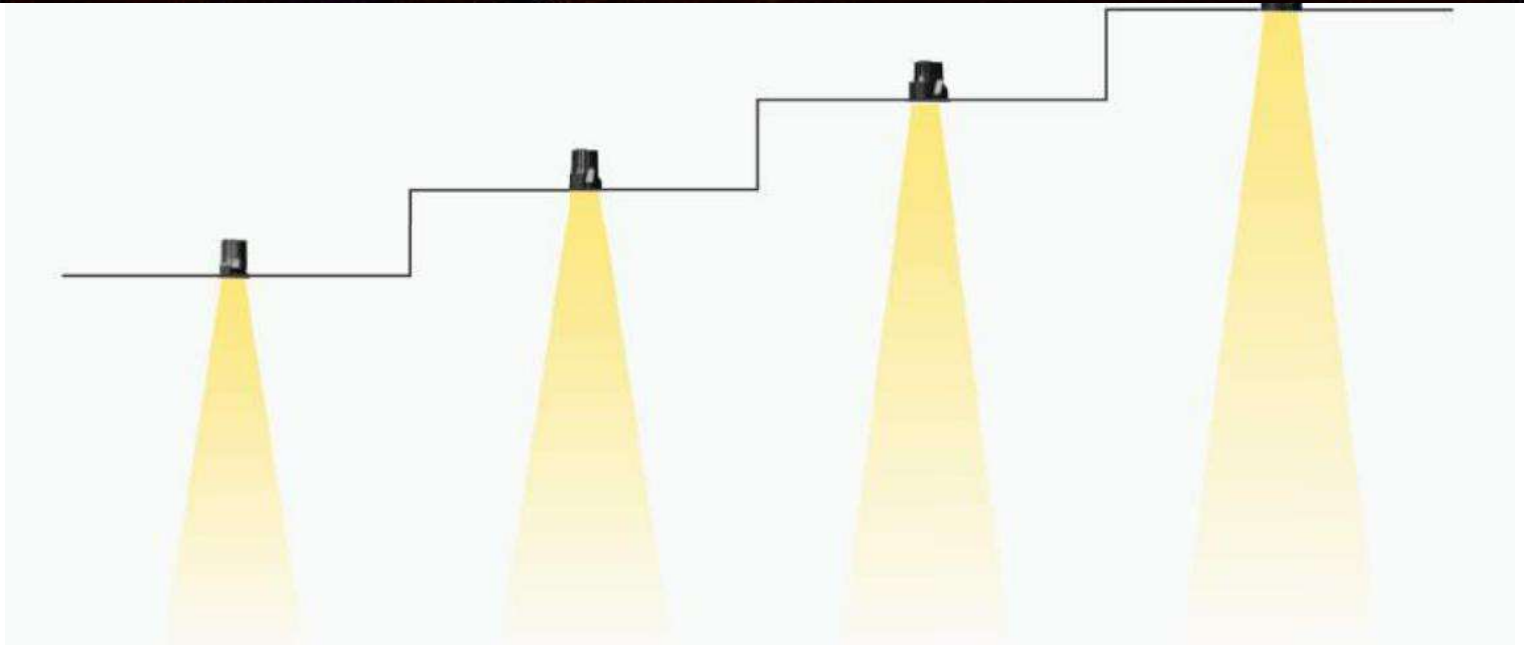
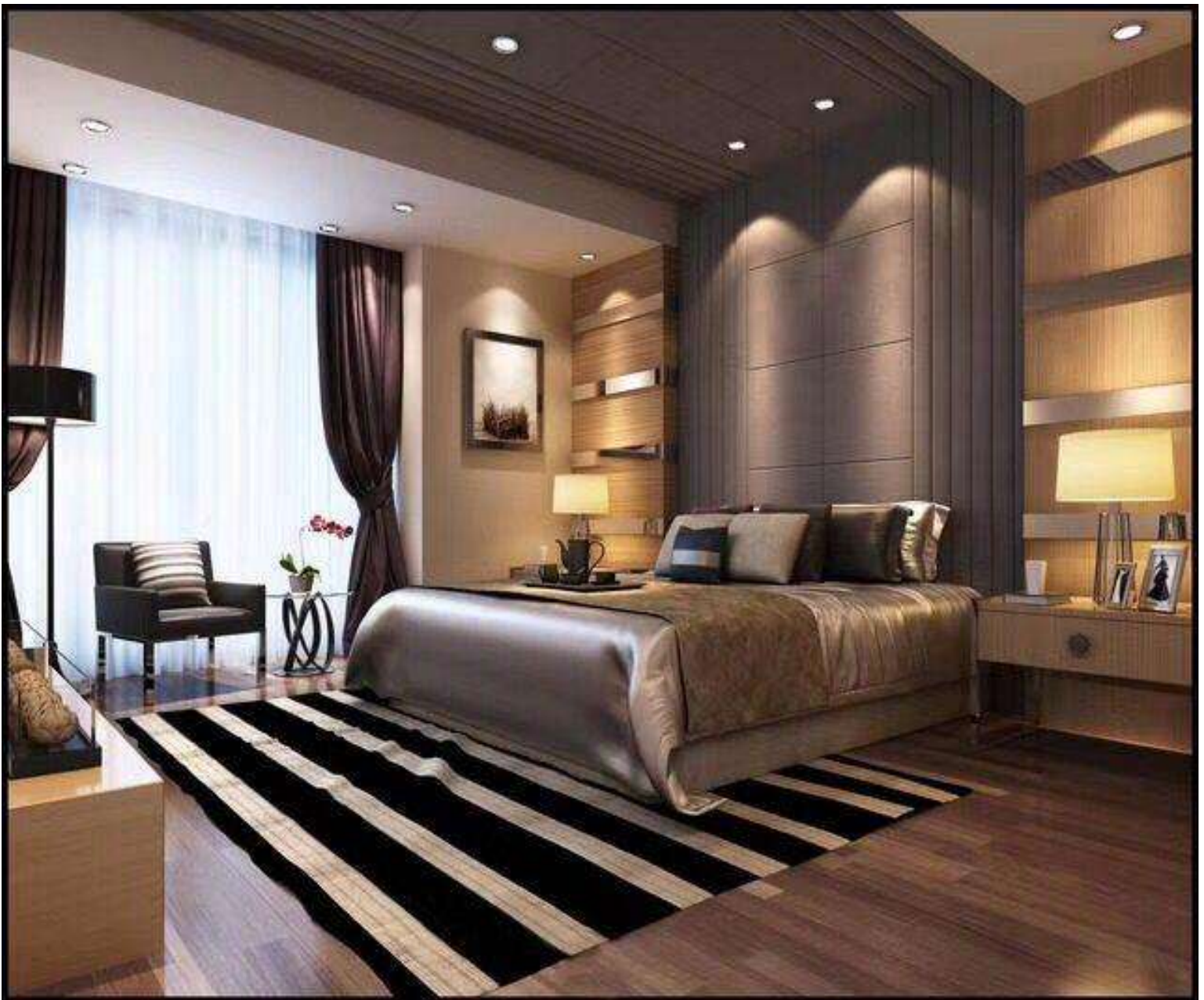

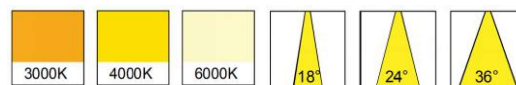
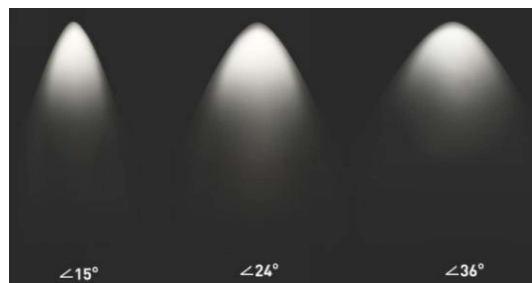
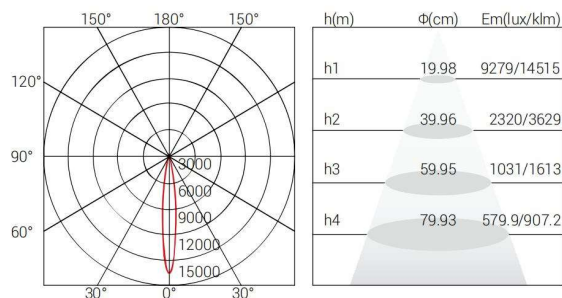

Model Code	A-806 / A-812 / A-820 / A-830
Power	6W / 12W / 20W / 30W
Size:	60x60xH77mm / 86x86xH104mm 106x106x119mm / 133x133x145mm
Cut out	Φ50/75/95/120mm
Light Source	Luminus / CREE
Optical	Lens

UGR	<18
Flicker	<15%
Beam angle	18° / 24° / 36°

CCT	3000K/4000K/6000K
Lumens	120lm / W
Power Factor	0.95
Efficiency	80%
Lifespan	50000h
Input Voltage	AC85-265V
IP	20
Driver	Eaglerise / Philips / Lifud
Material	Aluminium

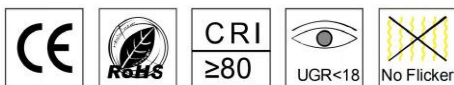

Finishing Color

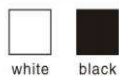

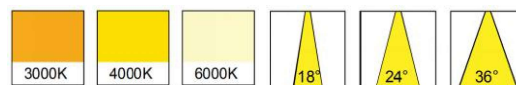
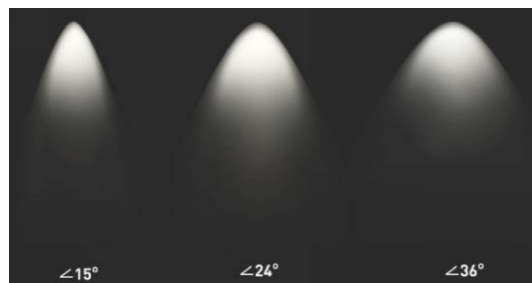
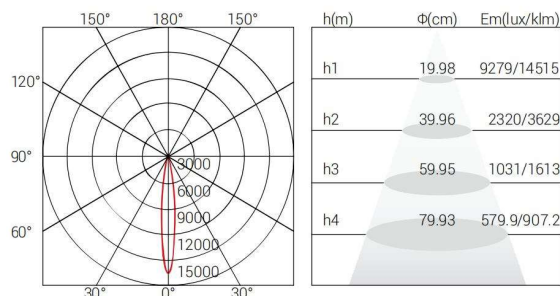

Model Code	A-606 / A-612 / A-620 / A-630
Power	6W / 12W / 20W / 30W
Size:	Φ60xH77mm / Φ86xH104mm Φ106xH119mm / Φ133xH145mm
Cut out	Φ50/75/95/120mm
Light Source	Luminus / CREE
Optical	Lens

UGR	<18
Fliker	<15%
Beam angle	18° / 24° / 36°

CCT	3000K/4000K/6000K
Lumens	120lm / W
Power Factor	0.95
Efficiency	80%
Lifespan	50000h
Input Voltage	AC85-265V
IP	20
Driver	Eaglerise / Philips / Lifud
Material	Aluminium

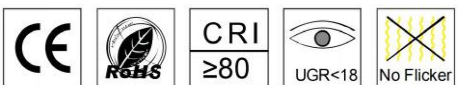

Finishing Color

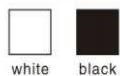

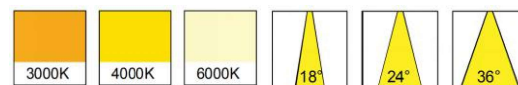
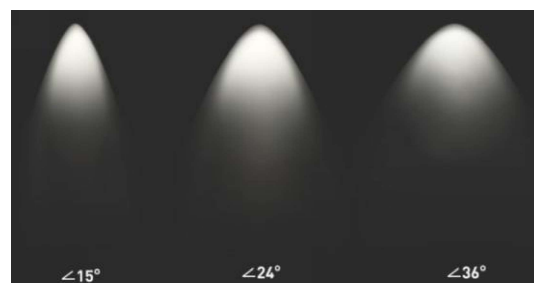
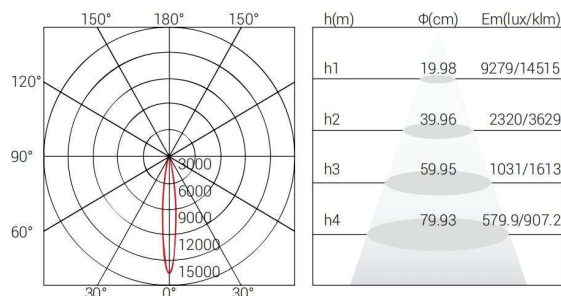

Model Code	A-206
Power	6W
Size:	Φ80xH81mm

Cut out	Φ70mm
Light Source	Luminus / CREE
Optical	Lens

UGR	<18
Fliker<15%	√
Beam angle	18° / 24° / 36°

CCT	3000K/4000K/6000K
Lumens	120lm / W
Power Factor	0.95
Efficiency	80%
Lifespan	50000h
Input Voltage	AC85-265V
IP	20
Driver	Eaglerise / Philips / Lifud
Material	Aluminium

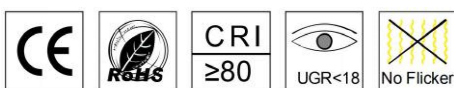

Finishing Color

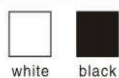

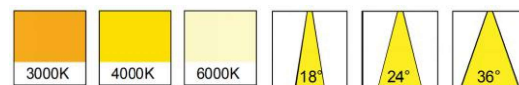
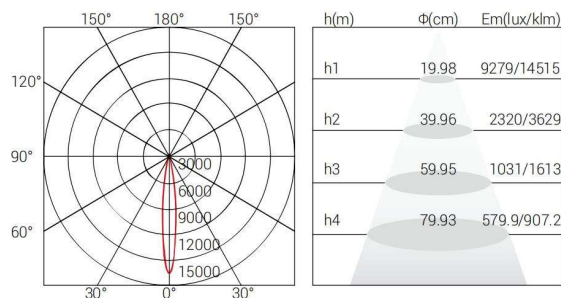

Model Code	DB12 / DB24 / DB40 / DB60
Power	12W / 24W / 40W / 60W
Size:	140*80xH81mm / 194*104xH81mm 240*126xH126mm / 298*153xH150mm
Cut out	130*70 / 182*92 / 226*113 / 283*138mm
Light Source	Luminus / CREE
Optical	Lens

UGR	<18
Fliker<15%	√
Beam angle	18° / 24° / 36°

CCT	3000K/4000K/6000K
Lumens	120lm / W
Power Factor	0.95
Efficiency	80%
Lifespan	50000h
Input Voltage	AC85-265V
IP	20
Driver	Eaglerise / Philips / Lifud
Material	Aluminium

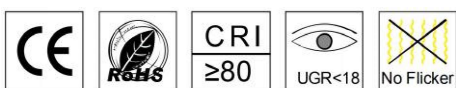

Finishing Color

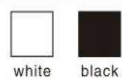

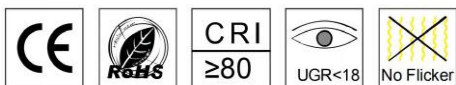
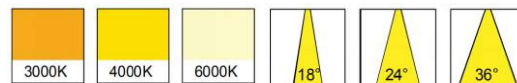
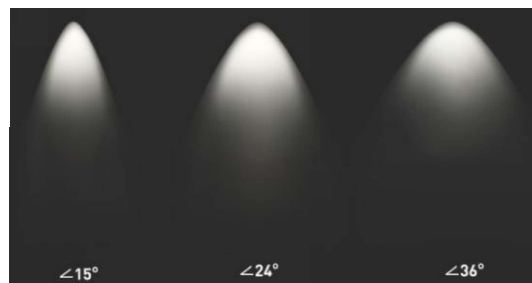
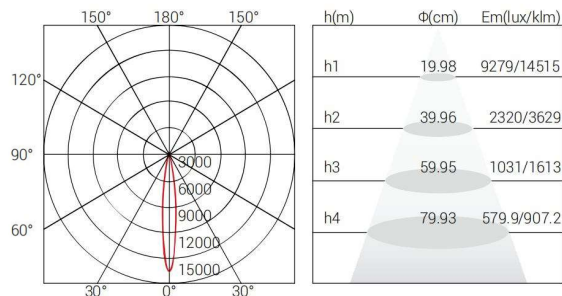
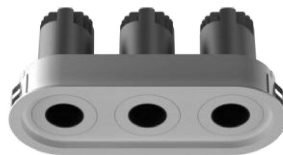

Finishing Color

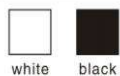

Model Code	DK18
Power	18W
Size:	200*70xH81mm

Cut out	190*70 mm
Light Source	Luminus / CREE
Optical	Lens

UGR	<18
Fliker<15%	√
Beam angle	18° / 24° / 36°

CCT	3000K/4000K/6000K
Lumens	120lm / W
Power Factor	0.95
Efficiency	80%
Lifespan	50000h
Input Voltage	AC85-265V
IP	20
Driver	Eaglerise / Philips / Lifud
Material	Aluminium

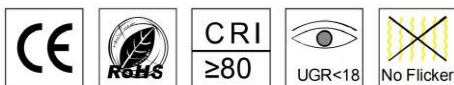
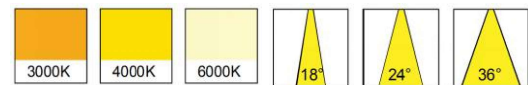
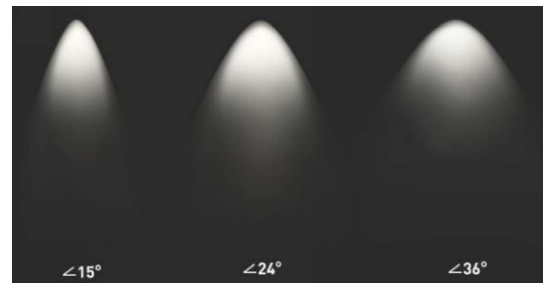
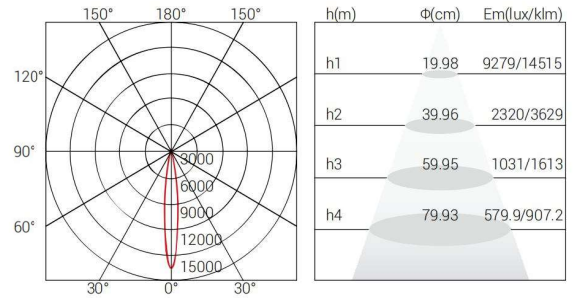

Finishing Color

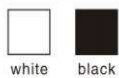

Model Code D406

Power 24W

Size: 140*140xH81mm

Cut out 130*130mm

Light Source Luminus / CREE

Optical Lens

UGR <18

Flicker <15% ✓

Beam angle 18° / 24° / 36°

CCT 3000K/4000K/6000K

Lumens 120lm / W

Power Factor 0.95

Efficiency 80%

Lifespan 50000h

Input Voltage AC85-265V

IP 20

Driver Eaglerise / Philips / Lifud

Material Aluminium

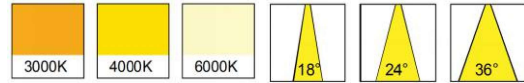
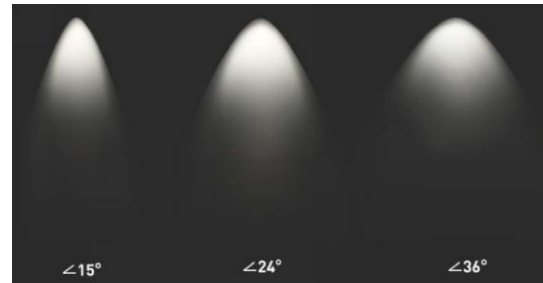
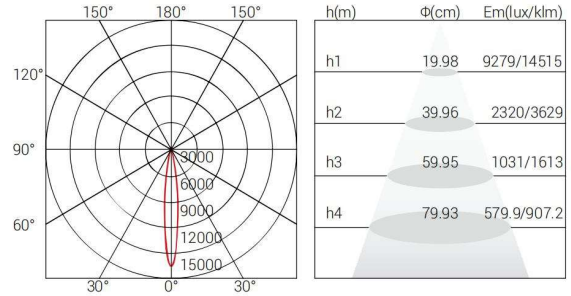

Model Code	D406
Power	6W / 12W / 20W / 30W
Size:	Φ94xH77mm / Φ127xH104mm Φ160xH119mm / Φ186xH145mm
Cut out	Φ50/75/95/120mm
Light Source	Luminus / CREE
Optical	Lens



UGR	<18
Flicker	<15%
Beam angle	18° / 24° / 36°

Finishing Color

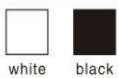

CCT	3000K/4000K/6000K
Lumens	120lm / W
Power Factor	0.95
Efficiency	80%
Lifespan	50000h
Input Voltage	AC85-265V
IP	20
Driver	Eaglerise / Philips / Lifud
Material	Aluminium

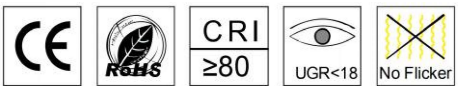
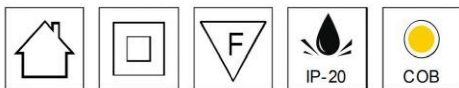
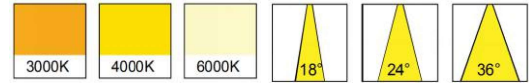
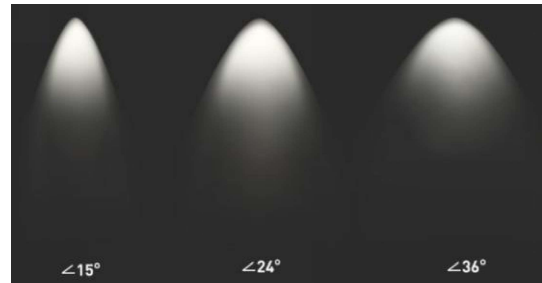
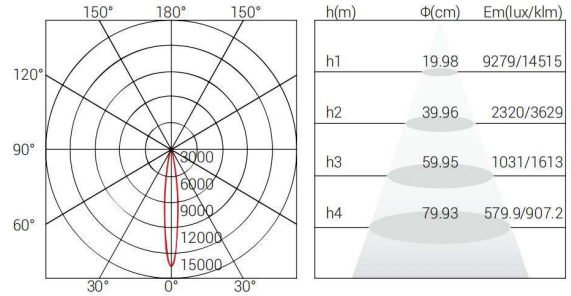

Finishing Color

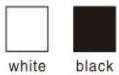

Model Code	B206 / B212 / B240 / B260
Power	12W / 24W / 40W / 60W
Size:	174*70*81mm / 246*89*109mm 293*108*106mm / 351*133*150mm
Cut out	130*70 / 182*92 / 226*113 / 282*136mm
Light Source	Luminus / CREE
Optical	Lens

UGR	<18
Flicker	<15%
Beam angle	18° / 24° / 36°

CCT	3000K/4000K/6000K
Lumens	120lm / W
Power Factor	0.95
Efficiency	80%
Lifespan	50000h
Input Voltage	AC85-265V
IP	20
Driver	Eaglerise / Philips / Lifud
Material	Aluminium

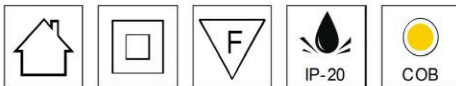
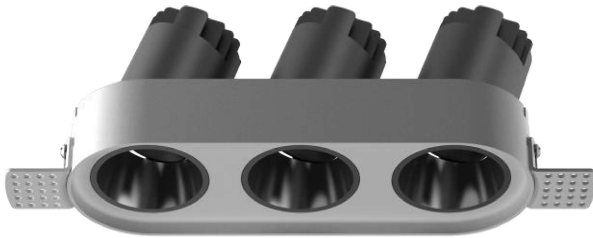
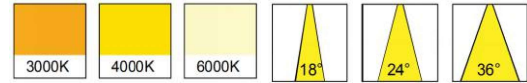
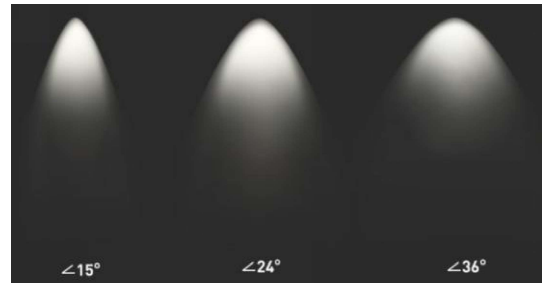
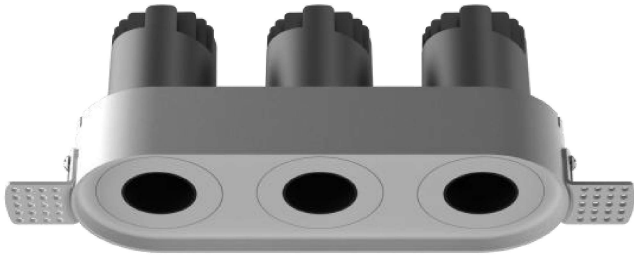
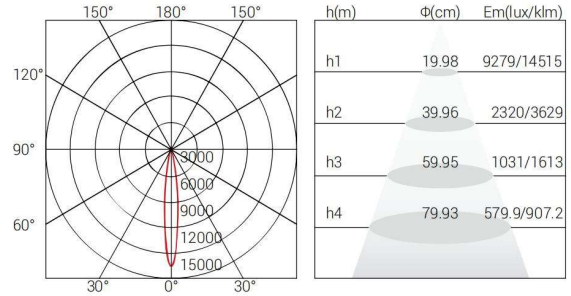
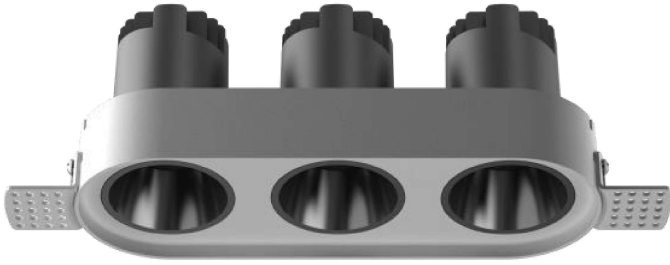

Finishing Color

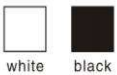

Model Code	B206 / B212 / B240 / B260
Power	12W / 24W / 40W / 60W
Size:	174*70*81mm / 246*89*109mm 293*108*106mm / 351*133*150mm
Cut out	130*70 / 182*92 / 226*113 / 282*136mm
Light Source	Luminus / CREE
Optical	Lens

UGR	<18
Flicker	<15%
Beam angle	18° / 24° / 36°

CCT	3000K/4000K/6000K
Lumens	120lm / W
Power Factor	0.95
Efficiency	80%
Lifespan	50000h
Input Voltage	AC85-265V
IP	20
Driver	Eaglerise / Philips / Lifud
Material	Aluminium

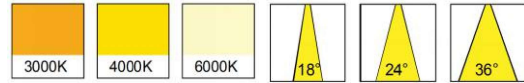
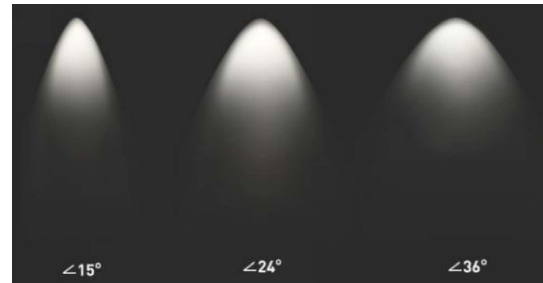
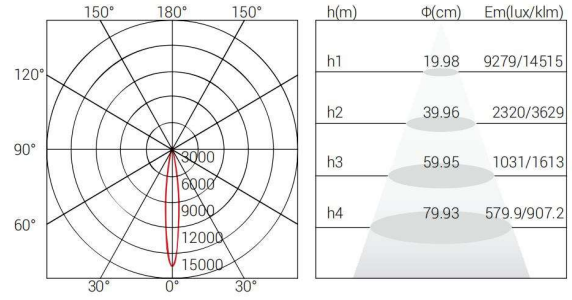

Finishing Color

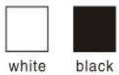

Model Code	H406
Power	24W
Size:	195*140*81mm

Cut out	130*130mm
Light Source	Luminus / CREE
Optical	Lens

UGR	<18
Flicker	<15%
Beam angle	18°/ 24°/36°

CCT	3000K/4000K/6000K
Lumens	120lm / W
Power Factor	0.95
Efficiency	80%
Lifespan	50000h
Input Voltage	AC85-265V
IP	20
Driver	Eaglerise / Philips / Lifud
Material	Aluminium

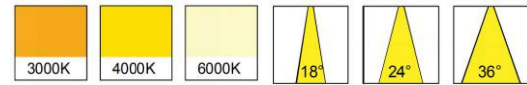
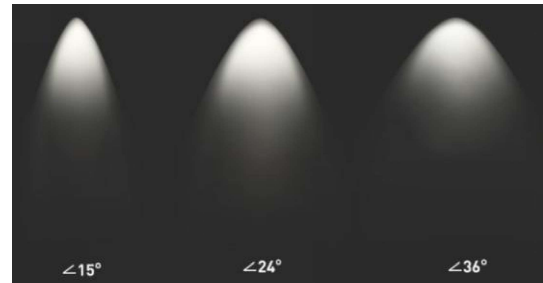
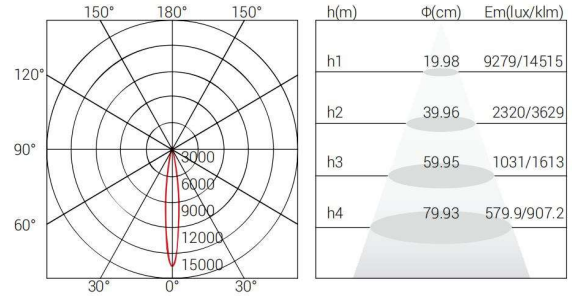

Model Code	X512 / X520 / X530
Power	12W / 20W / 30W
Size:	Φ127*104 / Φ160*119 / Φ186*145mm

Cut out	130*130mm
Light Source	Luminus / CREE
Optical	Lens

UGR	<18
Flicker	<15%
Beam angle	18° / 24° / 36°

CCT	3000K/4000K/6000K
Lumens	120lm / W
Power Factor	0.95
Efficiency	80%
Lifespan	50000h
Input Voltage	AC85-265V
IP	20
Driver	Eaglerise / Philips / Lifud
Material	Aluminium



Finishing Color

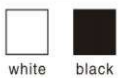

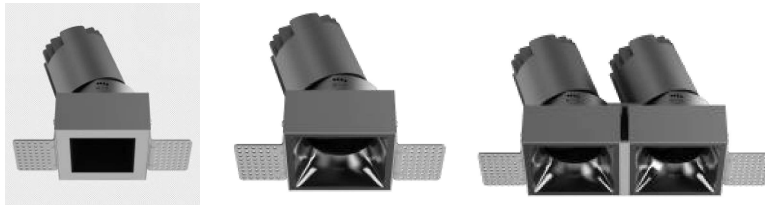
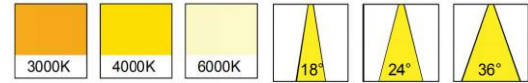
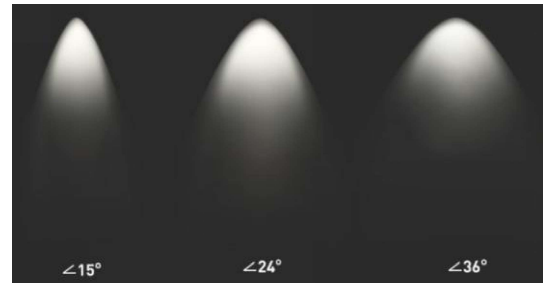
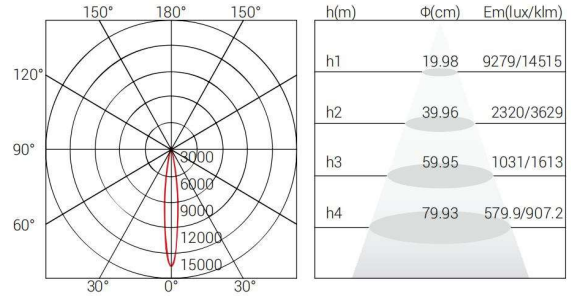
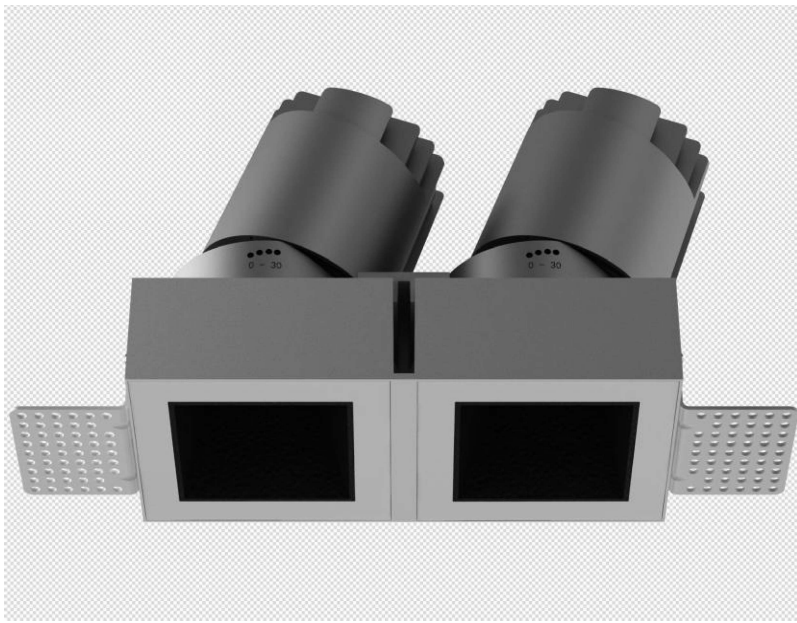

Finishing Color

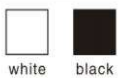

Model Code	M012 / M024
Power	12W / 24W
Size:	134*82*119mm / 227*82*121mm

Cut out	82*82/163*82mm
Light Source	Luminus / CREE
Optical	Lens

UGR	<18
Flicker	<15%
Beam angle	18° / 24° / 36°

CCT	3000K/4000K/6000K
Lumens	120lm / W
Power Factor	0.95
Efficiency	80%
Lifespan	50000h
Input Voltage	AC85-265V
IP	20
Driver	Eaglerise / Philips / Lifud
Material	Aluminium

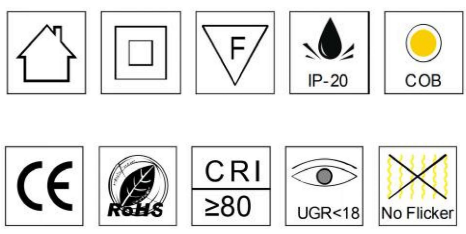
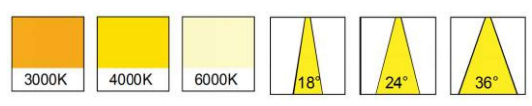
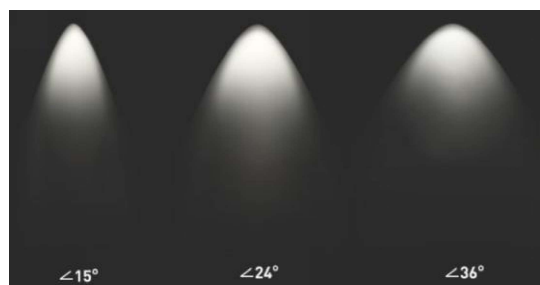
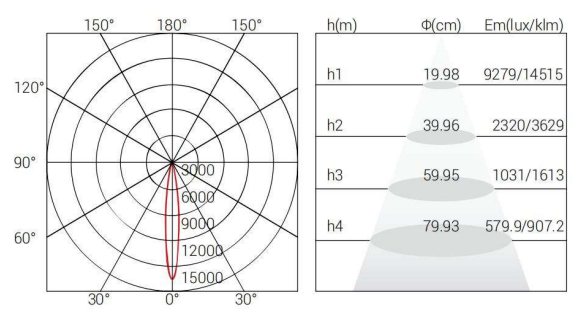
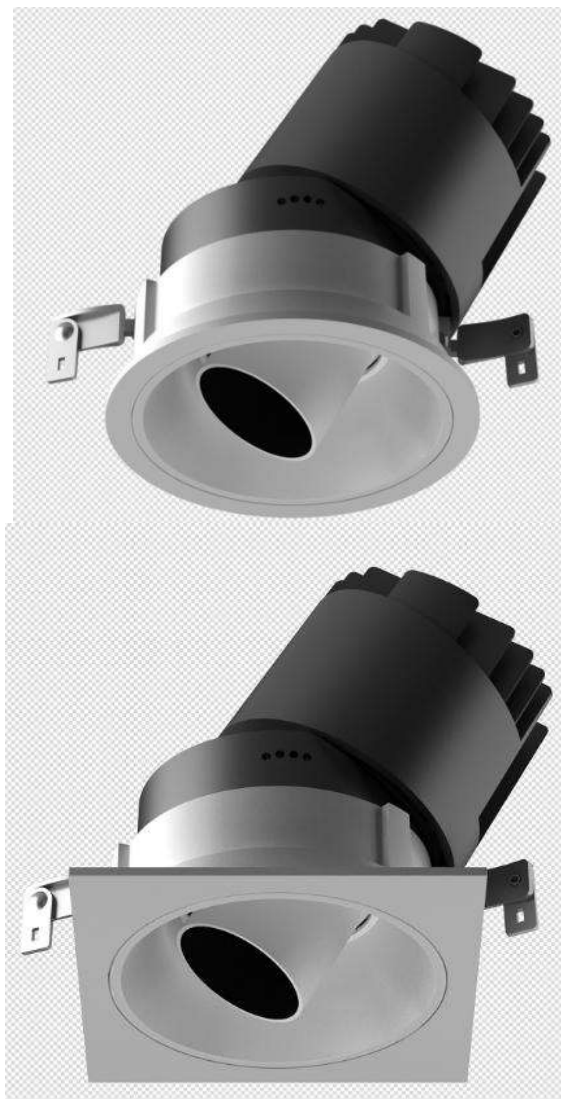

Finishing Color

white
 black

Model Code	X812 / X820 / X830
Power	12W / 20W / 30W
Size:	Φ86*104 / Φ106*119 / Φ133*145mm

Cut out	Φ75 / 95 / 120mm
Light Source	Luminus / CREE
Optical	Lens

UGR	<18
Fliker<15%	√
Beam angle	18° / 24° / 36°

CCT	3000K/4000K/6000K
Lumens	120lm / W
Power Factor	0.95
Efficiency	80%
Lifespan	50000h
Input Voltage	AC85-265V
IP	20
Driver	Eaglerise / Philips / Lifud
Material	Aluminium

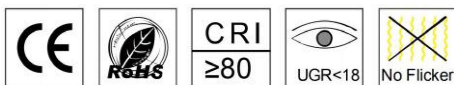
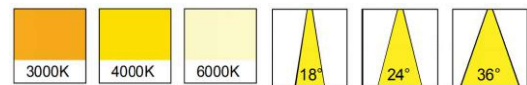
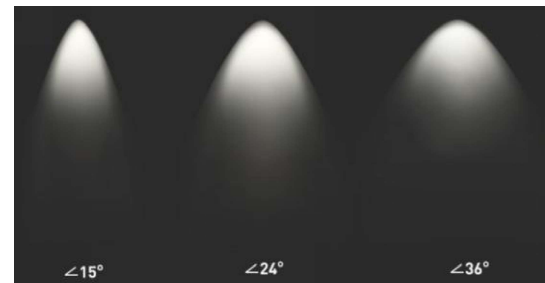
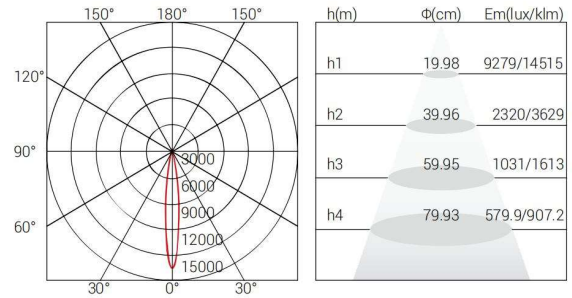

Finishing Color

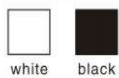

Model Code W012 / W024

Power 12W / 24W

Size: 89*89*119mm / 172*89*121mm

Cut out 82*82/163*82mm

Light Source Luminus / CREE

Optical Lens

UGR <18

Flicker <15% ✓

Beam angle 18° / 24° / 36°

CCT 3000K/4000K/6000K

Lumens 120lm / W

Power Factor 0.95

Efficiency 80%

Lifespan 50000h

Input Voltage AC85-265V

IP 20

Driver Eaglerise / Philips / Lifud

Material Aluminium



Model Code	JR06	JR12	JR18	JR30	JR35
Power	6W	12W	18W	30W	35W
Size:	Φ68*H80mm	Φ84*H105mm	Φ110*H132mm	Φ142*H153mm	Φ165*H178mm
Cut out	Φ55mm	Φ75mm	Φ95mm	Φ125mm	Φ150mm
Light Source	CREE	CREE	CREE	CREE	CREE
Optical	Reflector	Reflector	Reflector	Reflector	Reflector
UGR	<19	<19	<19	<19	<19
Fliker<15%	√	√	√	√	√
Beam angle	15°/ 24°/ 36°	15°/ 24°/ 36°	15°/ 24°/ 36°	15°/ 24°/ 36°	15°/ 24°/ 36°
CCT	3000K/4000K/6000K				
Power Factor	0.95	0.95	0.95	0.95	0.95
Efficiency	80%	80%	80%	80%	80%
Input Voltage	AC85-265V	AC85-265V	AC85-265V	AC85-265V	AC85-265V
Driver	Eaglerise /Lifud	Eaglerise /Lifud	Eaglerise /Lifud	Eaglerise /Lifud	Eaglerise /Lifud
IP	20	20	20	20	20
Material	Aluminium	Aluminium	Aluminium	Aluminium	Aluminium
Lifespan	50000h	50000h	50000h	50000h	50000h



Model Code	JS06	JS12	JS18	JS30	JS35
Power	6W	12W	18W	30W	35W
Size:	68*68*H80mm	84*84*H105mm	110*110*H132mm	142*142*H153mm	165*165*H178mm
Cut out	55*55mm	75*75mm	95*95mm	125*125mm	150*150mm
Light Source	CREE	CREE	CREE	CREE	CREE
Optical	Reflector	Reflector	Reflector	Reflector	Reflector
UGR	<19	<19	<19	<19	<19
Fliker<15%	√	√	√	√	√
Beam angle	15°/ 24°/ 36°	15°/ 24°/ 36°	15°/ 24°/ 36°	15°/ 24°/ 36°	15°/ 24°/ 36°
CCT	3000K/4000K/6000K				
Power Factor	0.95	0.95	0.95	0.95	0.95
Efficiency	80%	80%	80%	80%	80%
Input Voltage	AC85-265V	AC85-265V	AC85-265V	AC85-265V	AC85-265V
Driver	Eaglerise /Lifud	Eaglerise /Lifud	Eaglerise /Lifud	Eaglerise /Lifud	Eaglerise /Lifud
IP	20	20	20	20	20
Material	Aluminium	Aluminium	Aluminium	Aluminium	Aluminium
Lifespan	50000h	50000h	50000h	50000h	50000h

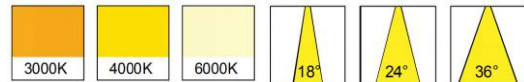
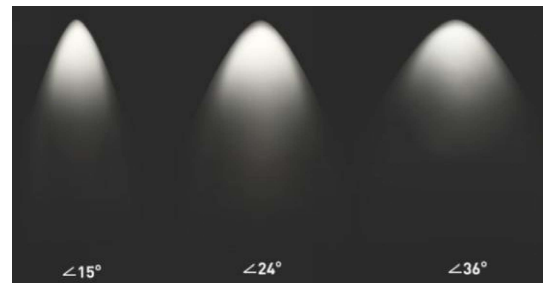
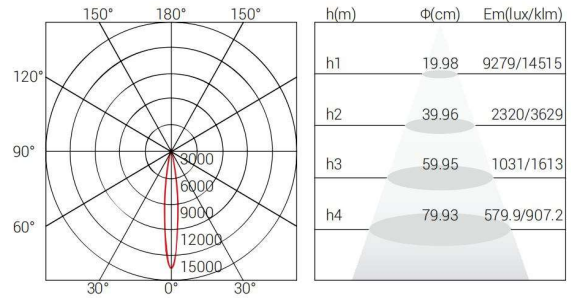

Finishing Color

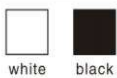

Model Code	L015
Power	15W
Size:	Φ70*145mm
Cut out	Φ60mm
Light Source	Luminus / CREE
Optical	Lens

UGR	<18
Flicker	<15%
Beam angle	18°/24°/36°

CCT	3000K/4000K/6000K
Lumens	1200lm
Power Factor	0.95
Efficiency	80%
Lifespan	50000h
Input Voltage	AC85-265V
IP	20
Driver	Eaglerise / Philips / Lifud
Material	Aluminium

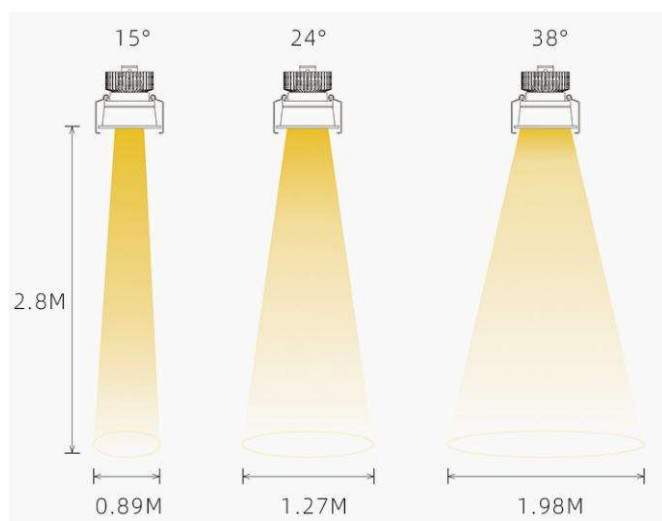
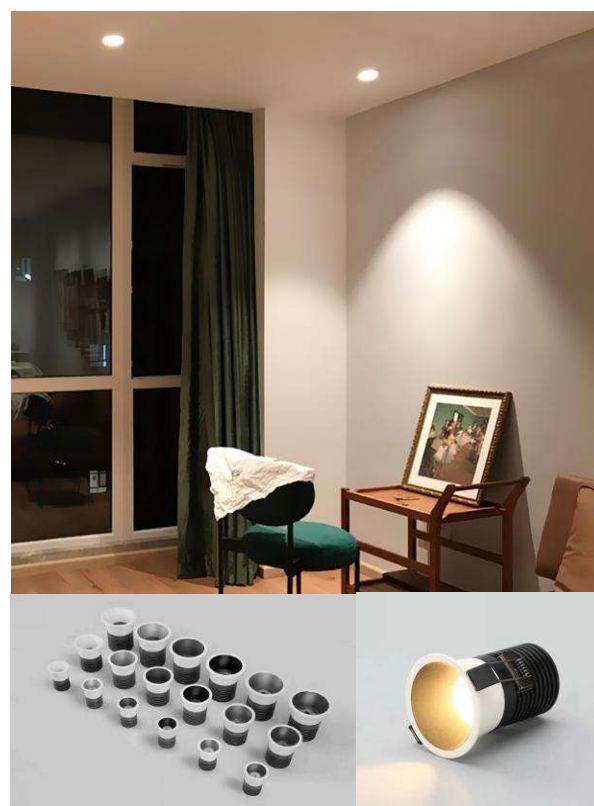

Model Code	S203 , S207 , S215
Power	3W / 7W / 15W
Size:	Φ40*H58 / Φ60*H84 / Φ75*H100mm
Cut out	Φ35 / Φ58 / Φ70mm
Light Source	Luminus / CREE
Optical	Lens

UGR	<18
Flicker	<15% ✓
Beam angle	18° / 24° / 36°

CCT	3000K / 4000K / 6000K
Lumens	240lm / 560lm / 1200lm
Power Factor	0.95
Efficiency	80%
Lifespan	50000h
Input Voltage	AC85-265V
IP	20
Driver	Eaglerise / Philips / Lifud
Material	Aluminium

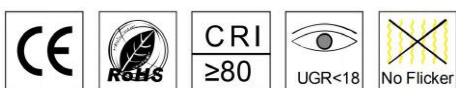

Finishing Color

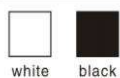

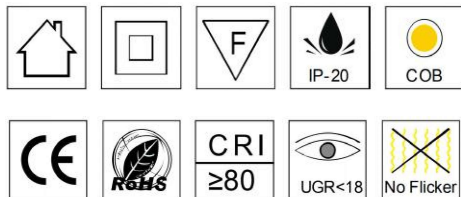
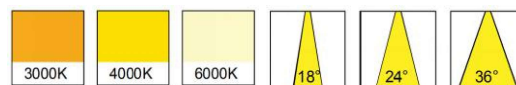
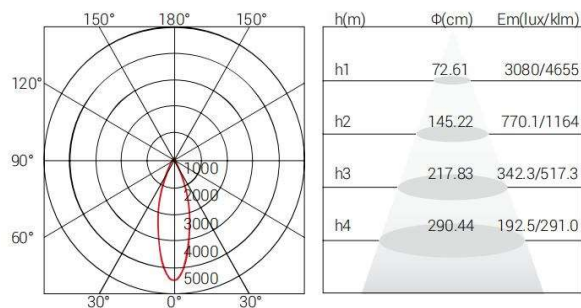

Model Code	Q725
Power	25W
Size:	Φ100*155mm
Cut out	Φ90mm
Light Source	Luminus / CREE
Optical	Lens

UGR	<18
Flicker	<15%
Beam angle	18° / 24° / 36°

CCT	3000K/4000K/6000K
Lumens	2000lm
Power Factor	0.95
Efficiency	80%
Lifespan	50000h
Input Voltage	AC85-265V
IP	20
Driver	Eaglerise / Philips / Lifud
Material	Aluminium

Finishing Color

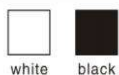

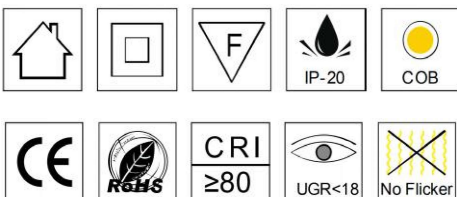
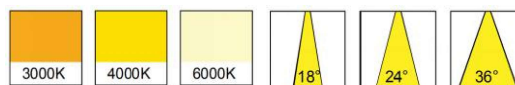
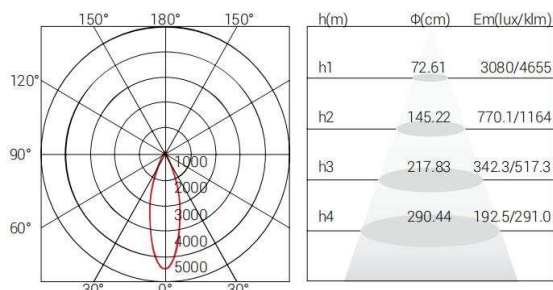

Finishing Color

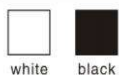

Model Code	FS03 / FS07
Power	3W / 7W
Size:	Φ75*H51mm / Φ85*H65mm
Cut out	Surface Mounted
Light Source	Luminus / CREE
Optical	Lens

UGR	<18
Fliker<15%	√
Beam angle	18° / 24° / 36°

CCT	3000K/4000K/6000K
Lumens	240lm / 560lm
Power Factor	0.95
Efficiency	80%
Lifespan	50000h
Input Voltage	AC85-265V
IP	20
Driver	Eaglerise / Philips / Lifud
Material	Aluminium



Model Code	A-H10,A-H15,A-H25	UGR	<19	Input Voltage	AC85-265V
Power	10W /15W/25W	Fliker<15%	√	Driver	Eaglerise
Size:	Φ72*H103/ Φ84*H106/Φ103*H115mm Beam angle		18°/ 24°/ 36°	IP	20
Cut out	Surface mounted and hanging	CCT	3000K/4000K/6000K	Material	Aluminium
Light Source	Luminus / CREE	Power Factor	0.95	Lifespan	50000h
Optical	Lens	Efficiency	80%		

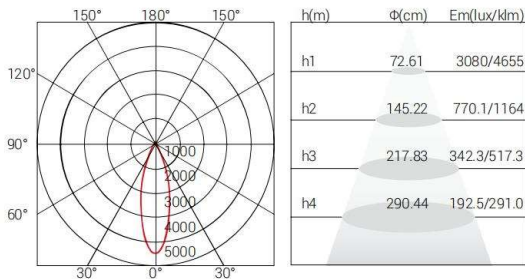

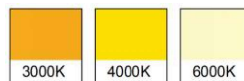
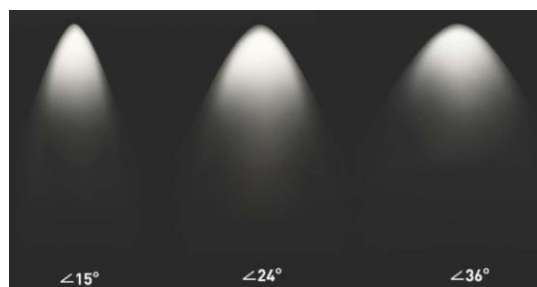
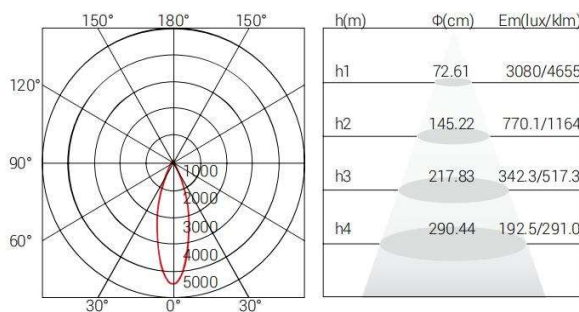

Model Code	TD10 / TD15
Power	10W / 15W
Size:	Φ72*H76mm / Φ88*H88mm
Cut out	Φ65mm / Φ80mm
Light Source	Luminus / CREE
Optical	Lens

UGR	<22
Fliker<15%	√
Beam angle	15°/24°/36°

CCT	3000K/4000K/6000K
Lumens	800lm / 1200lm
Power Factor	0.95
Efficiency	80%
Lifespan	50000h
Input Voltage	AC85-265V
IP	20
Driver	Eaglerise / Philips / Lifud
Material	Aluminium

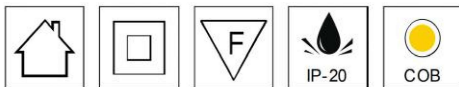

Finishing Color

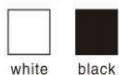

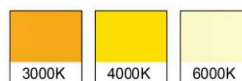
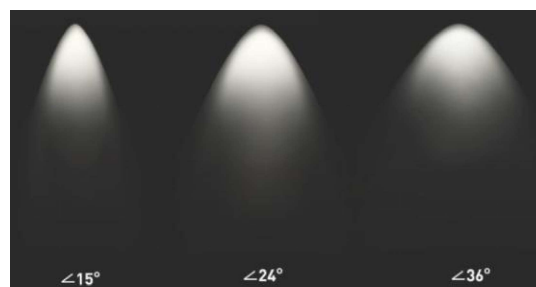
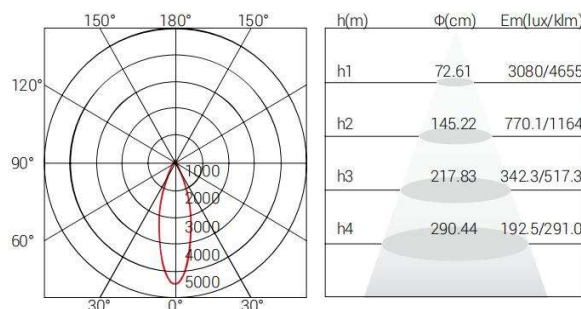

Finishing Color

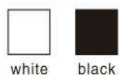

Model Code	V05 / V10 / V20
Power	5W / 10W / 20W
Size:	Φ62*H55 / Φ85*H70mm / Φ105*H85mm
Cut out	Φ55 / Φ75 / Φ95mm
Light Source	Luminus / CREE
Optical	Lens

UGR	<22
Fliker<15%	√
Beam angle	15°/24°/36°

CCT	3000K/4000K/6000K
Lumens	400lm / 800lm / 1600lm
Power Factor	0.95
Efficiency	80%
Lifespan	50000h
Input Voltage	AC85-265V
IP	20
Driver	Eaglerise / Philips / Lifud
Material	Aluminium

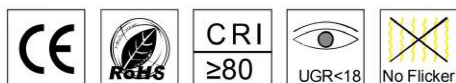
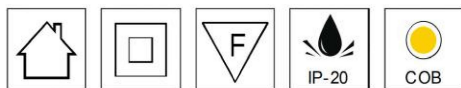
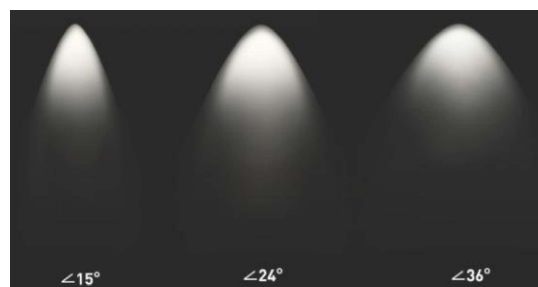
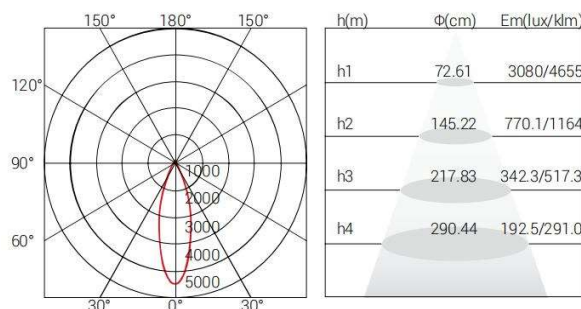

Finishing Color

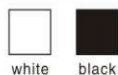

Model Code	ZS06 / ZS10 / ZS15 / ZS25
Power	6W / 10W / 15W / 25W
Size:	Φ65*75/Φ88*9/110*110/135*120mm
Cut out	Φ55mm / Φ75mm / Φ95mm / Φ120mm
Light Source	Luminus / CREE
Optical	Lens

UGR	<22
Flicker<15%	√
Beam angle	15°/24°/36°

CCT	3000K/4000K/6000K
Lumens	480lm / 800lm / 1200 lm / 2000lm
Power Factor	0.95
Efficiency	80%
Lifespan	50000h
Input Voltage	AC85-265V
IP	20
Driver	Eaglerise / Philips / Lifud
Material	Aluminium

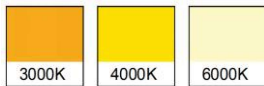
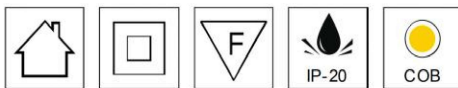

Finishing Color

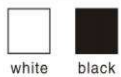

Model Code	WL10 / WL18 / WL30
Power	10W / 18W / 30W
Size:	Φ85*70 / Φ108*85 / Φ135*97mm
Cut out	Φ75 / Φ95 / Φ125mm
Light Source	CREE XPE2-3535
Optical	Lens

UGR	<19
Flicker<15%	√
Beam angle	39°

CCT	3000K/4000K/6000K
Lumens	120lm / W
Power Factor	0.95
Efficiency	80%
Lifespan	50000h
Input Voltage	AC85-265V
IP	20
Driver	Eaglerise / Philips / Lifud
Material	Aluminium

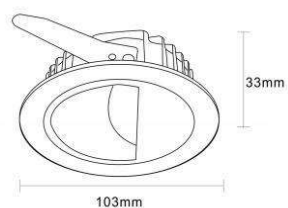
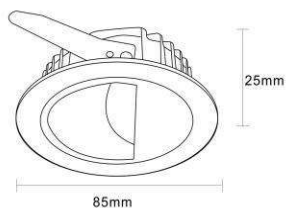

Model Code	E05 / E10
Power	5W / 12W
Size:	Φ85*25mm / Φ103*33mm
Cut out	Φ75mm / Φ90mm
Light Source	CREE XPE2-3535
Optical	Lens

UGR	<22
Flicker	<15%
Beam angle	39°

CCT	3000K/4000K/6000K
Lumens	120lm / W
Power Factor	0.95
Efficiency	80%
Lifespan	50000h
Input Voltage	AC85-265V
IP	20
Driver	Eaglerise / Philips / Lifud
Material	Aluminium



Finishing Color

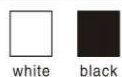

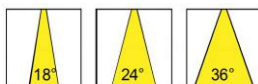
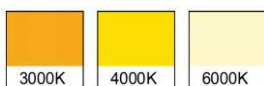

Model Code	KR12
Power	12W
Size:	Φ85*88mm
Cut out	Φ75mm
Light Source	CREE
Optical	Lens

UGR	<22
Flicker<15%	√
Beam angle	18° / 24° / 36°

CCT	3000K/4000K/6000K
Lumens	120lm / W
Power Factor	0.95
Efficiency	80%
Lifespan	50000h
Input Voltage	AC85-265V
IP	20
Driver	Eaglerise / Philips / Lifud
Material	Aluminium

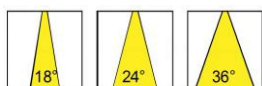
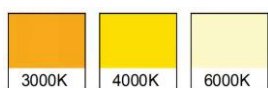

Finishing Color

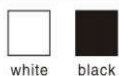

white black

Model Code	DR12
Power	12W
Size:	Φ85*88mm
Cut out	Φ75mm
Light Source	CREE
Optical	Lens

UGR	<22
Flicker<15%	√
Beam angle	18° / 24° / 36°

CCT	3000K/4000K/6000K
Lumens	120lm / W
Power Factor	0.95
Efficiency	80%
Lifespan	50000h
Input Voltage	AC85-265V
IP	20
Driver	Eaglerise / Philips / Lifud
Material	Aluminium

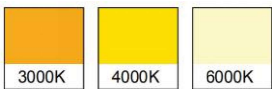

Model Code	KN12
Power	12W
Size:	88*88mm
Cut out	80*80mm
Light Source	CREE XPE2-3535
Optical	Lens

UGR	<22
Fliker<15%	√
Beam angle	18° / 24° / 36°

CCT	3000K/4000K/6000K
Lumens	120lm / W
Power Factor	0.95
Efficiency	80%
Lifespan	50000h
Input Voltage	AC85-265V
IP	20
Driver	Eaglerise / Philips / Lifud
Material	Aluminium

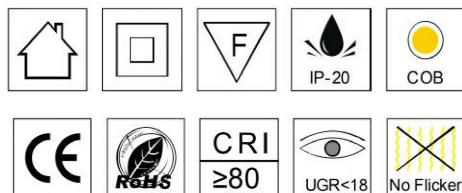
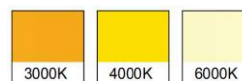
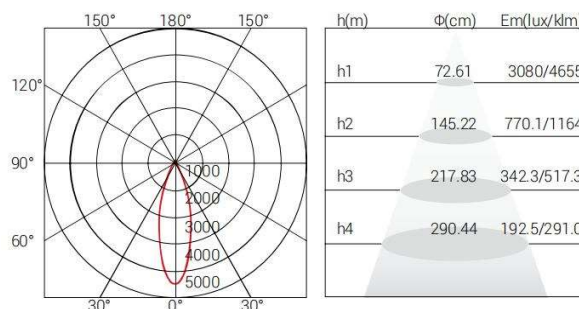

Finishing Color

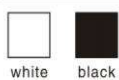

Model Code	NT05 / NT10 / NT15 / NT20
Power	5W / 10W / 15W / 20W
Size:	Φ55*H75/Φ75*H106/91*H120mm/Φ128*H130mm
Cut out	Φ50mm / Φ68mm / Φ82mm / Φ118mm
Light Source	Luminus / CREE
Optical	Lens

UGR	<16
Flicker	<15%
Beam angle	12°/24°/38°

CCT	3000K/4000K/6000K
Lumens	400lm / 800lm / 1200lm/ 1600lm
Power Factor	0.95
Efficiency	80%
Lifespan	50000h
Input Voltage	AC85-265V
IP	20
Driver	Eaglerise / Philips / Lifud
Material	Aluminium



X12A



X12C



X12D



X12E

Model Code	X12B	UGR	<19	Input Voltage	AC85-265V
Power	12W	Fliker	<15%	Driver	Eaglerise /Lifud
Size:	Φ90*H120mm	Beam angle	18°/ 24°/ 36°	IP	20
Cut out	Φ80mm	CCT	3000K/4000K/6000K	Material	Aluminium
Light Source	Luminus / CREE	Power Factor	0.95	Lifespan	50000h
Optical	Lens	Efficiency	80%		

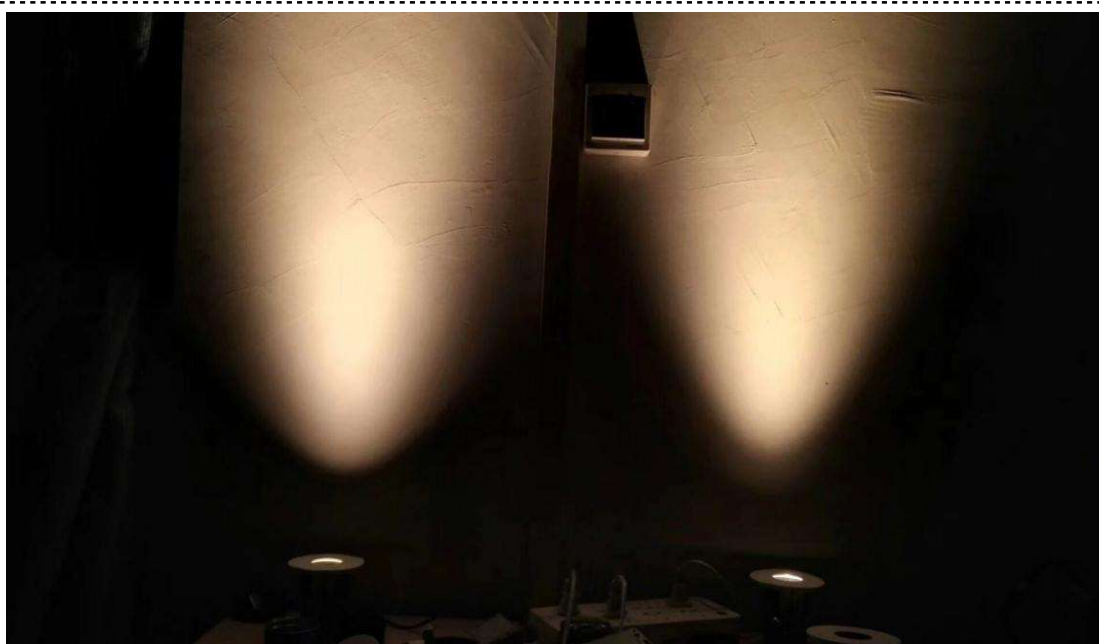



Model Code	GY12	UGR	<19	Input Voltage	AC85-265V
Power	12W	Fliker	<15%	Driver	Eaglerise /Lifud
Size:	Φ90*H120mm	Beam angle	18°/ 24°/ 36°	IP	20
Cut out	Φ80mm	CCT	3000K/4000K/6000K	Material	Aluminium
Light Source	Luminus / CREE	Power Factor	0.95	Lifespan	50000h
Optical	Lens	Efficiency	80%		

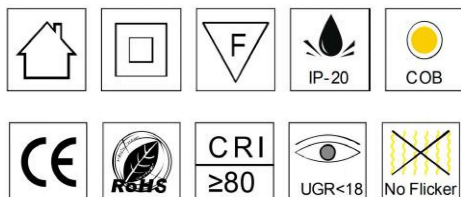
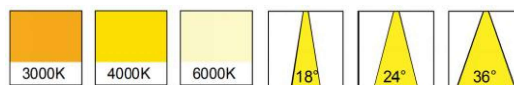
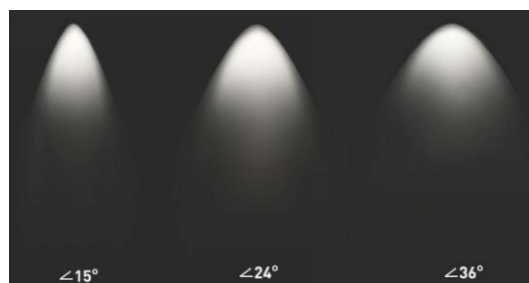
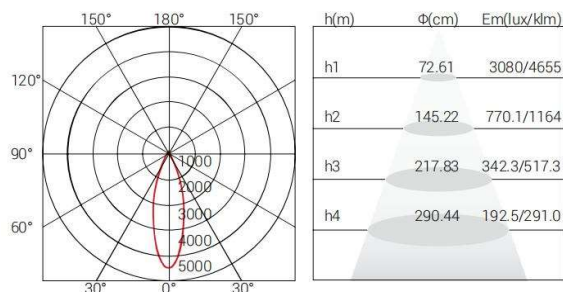

Model Code	T-P12
Power	12W
Size:	Φ82*H118mm
Cut out	Φ75mm
Light Source	Luminus / CREE
Optical	Lens

UGR	<18
Flicker	<15%
Beam angle	18° / 24° / 36°

CCT	3000K/4000K/6000K
Lumens	960lm
Power Factor	0.95
Efficiency	80%
Lifespan	50000h
Input Voltage	AC85-265V
IP	20
Driver	Eaglerise / Philips / Lifud
Material	Aluminium

Finishing Color

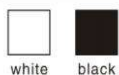

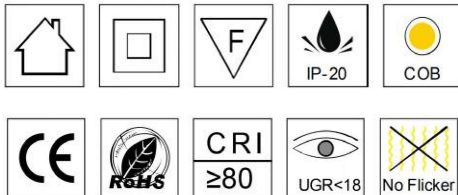
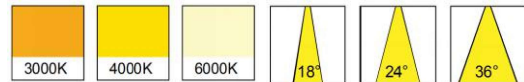
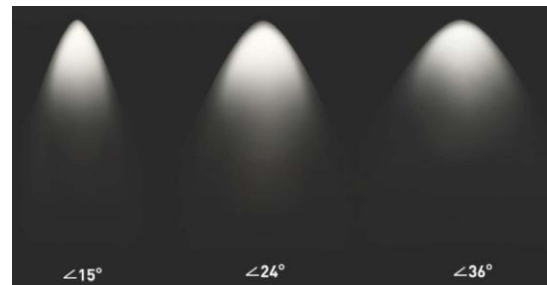
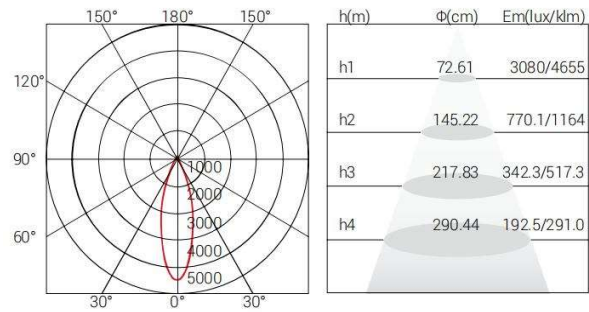

Model Code	T-P10 / T-P15
Power	10W / 15W
Size:	Φ105*H104mm / Φ115*H125mm
Cut out	Φ85mm / Φ95mm
Light Source	Luminus / CREE
Optical	Lens

UGR	<18
Flicker	<15%
Beam angle	18° / 24° / 36°

CCT	3000K/4000K/6000K
Lumens	800lm / 1200lm
Power Factor	0.95
Efficiency	80%
Lifespan	50000h
Input Voltage	AC85-265V
IP	20
Driver	Eaglerise / Philips / Lifud
Material	Aluminium

Finishing color

siliver , gold

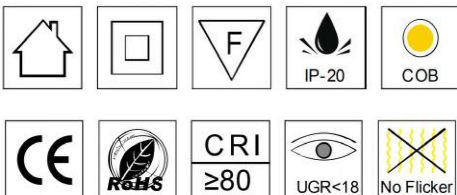
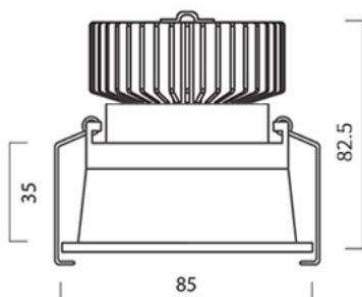
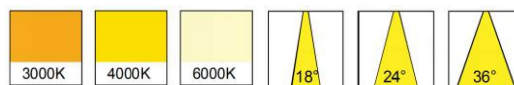
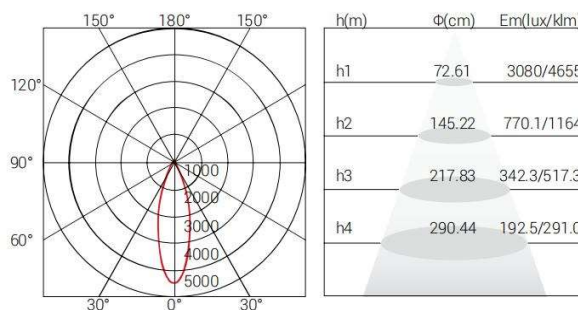

Finishing Color

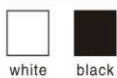

Model Code	R512
Power	12W
Size:	Φ85*H82.5mm
Cut out	Φ75mm
Light Source	Luminus / CREE
Optical	Lens

UGR	<18
Flicker	<15%
Beam angle	18° / 24° / 36°

CCT	3000K/4000K/6000K
Lumens	960lm
Power Factor	0.95
Efficiency	80%
Lifespan	50000h
Input Voltage	AC85-265V
IP	20
Driver	Eaglerise / Philips / Lifud
Material	Aluminium

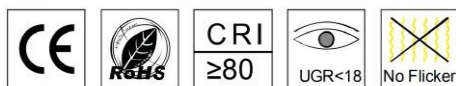
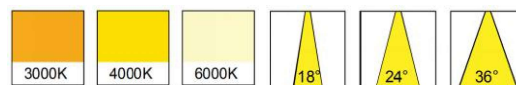
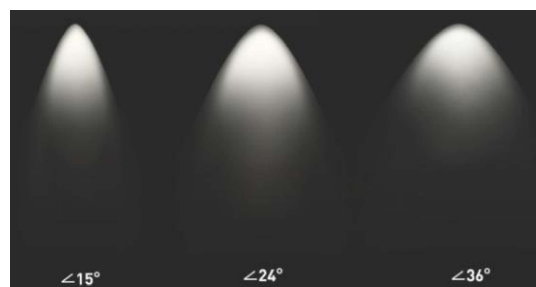
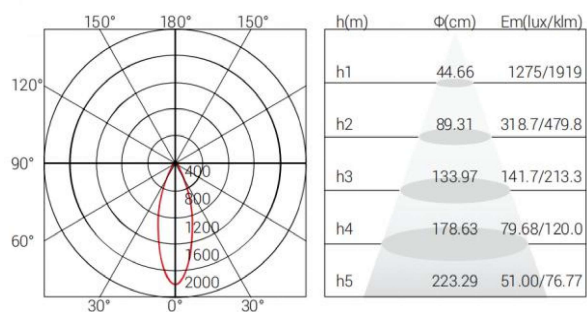

Finishing color

white ,chrome, gold , silver

Model Code	T-B07
Power	7W
Size:	Φ80*H70mm
Cut out	Φ75mm
Light Source	Luminus / CREE
Optical	Lens

UGR	< 18
Fliker < 15%	√
Beam angle	18° / 24° / 36°

CCT	3000K/4000K/6000K
Lumens	560lm
Power Factor	0.95
Efficiency	80%
Lifespan	50000h
Input Voltage	AC85-265V
IP	20
Driver	Eaglerise / Philips / Lifud
Material	Aluminium

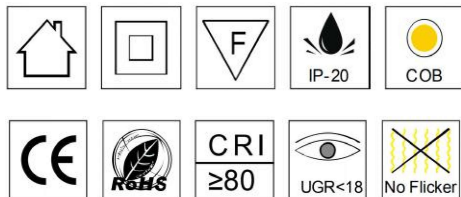
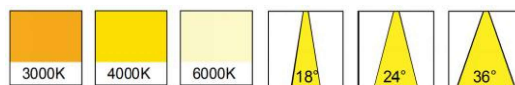
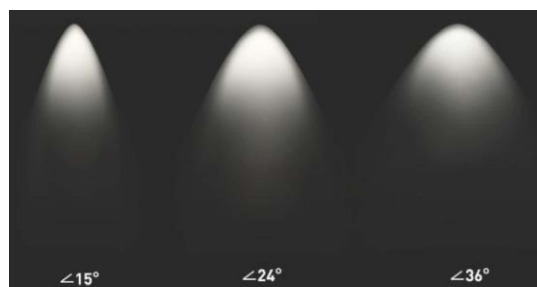
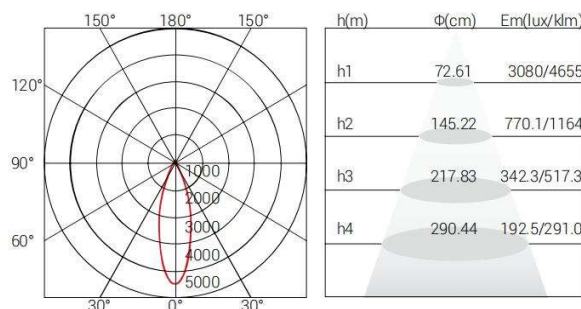

Model Code	T-P10 / T-P15
Power	10W / 15W
Size:	Φ105*H104mm / Φ115*H125mm
Cut out	Φ85mm / Φ95mm
Light Source	Luminus / CREE
Optical	Lens

UGR	<18
Flicker	<15%
Beam angle	18° / 24° / 36°

CCT	3000K/4000K/6000K
Lumens	800lm / 1200lm
Power Factor	0.95
Efficiency	80%
Lifespan	50000h
Input Voltage	AC85-265V
IP	20
Driver	Eaglerise / Philips / Lifud
Material	Aluminium

Finishing color

siliver , gold

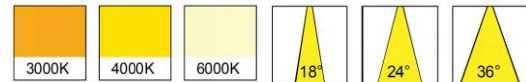
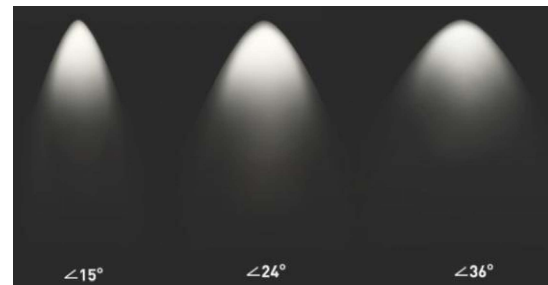
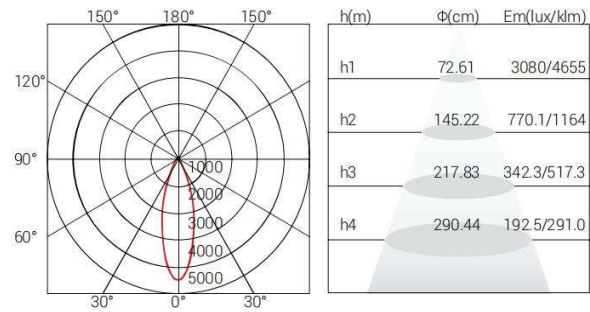

Model Code	R807 / R812 / R820
Power	7W / 12W / 20W
Size:	Φ90*H90 / Φ107*H110 / Φ135*H145mm
Cut out	Φ80 / Φ95 / Φ125mm
Light Source	Luminus / CREE
Optical	Lens

UGR	<18
Flicker	<15%
Beam angle	18° / 24° / 36°

CCT	3000K/4000K/6000K
Lumens	120lm / W
Power Factor	0.95
Efficiency	80%
Lifespan	50000h
Input Voltage	AC85-265V
IP	20
Driver	Eaglerise / Philips / Lifud
Material	Aluminium

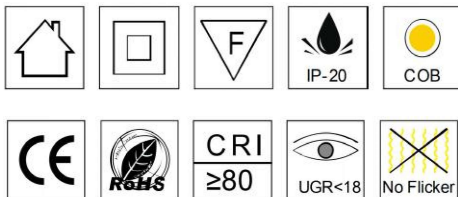

Finishing Color

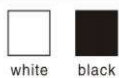

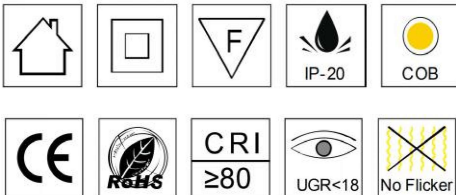
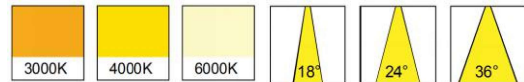
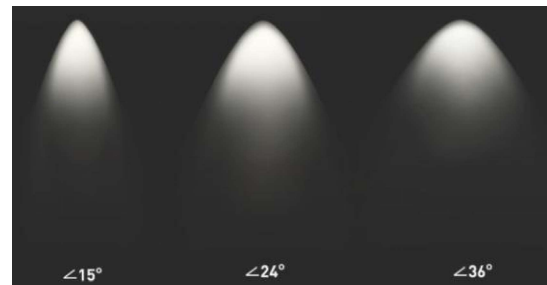
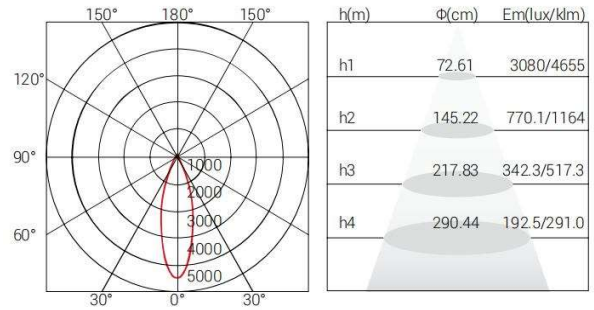

Finishing Color

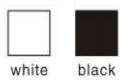

Model Code	S807/ S812 / S820
Power	7W / 12W / 20W
Size:	90*H90 / 107*H110 / 135*H145mm
Cut out	Φ80 / Φ95 / Φ125mm
Light Source	Luminus / CREE
Optical	Lens

UGR	<18
Fliker<15%	√
Beam angle	18° / 24° / 36°

CCT	3000K/4000K/6000K
Lumens	120lm / W
Power Factor	0.95
Efficiency	80%
Lifespan	50000h
Input Voltage	AC85-265V
IP	20
Driver	Eaglerise / Philips / Lifud
Material	Aluminium

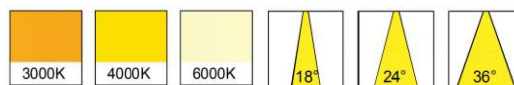
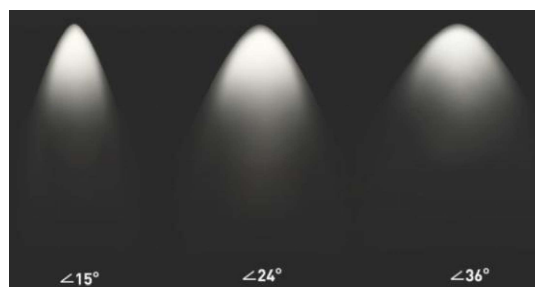
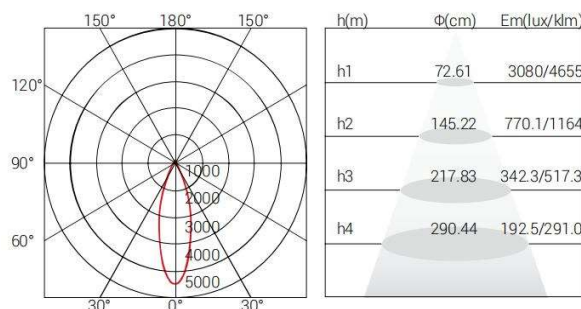

Finishing Color

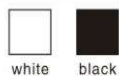

Model Code	AW-10W
Power	10W
Size:	95*H94mm
Cut out	Φ85mm
Light Source	Luminus / CREE
Optical	Lens

UGR	<18
Flicker	<15%
Beam angle	18° / 24° / 36°

CCT	3000K/4000K/6000K
Lumens	800lm
Power Factor	0.95
Efficiency	80%
Lifespan	50000h
Input Voltage	AC85-265V
IP	20
Driver	Eaglerise / Philips / Lifud
Material	Aluminium

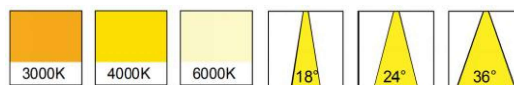
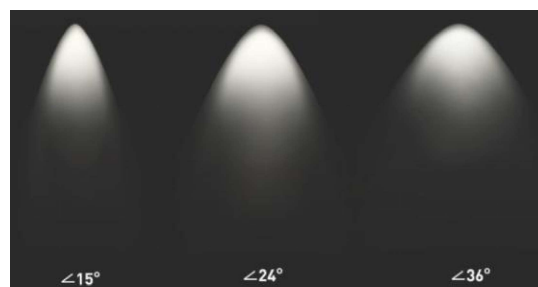
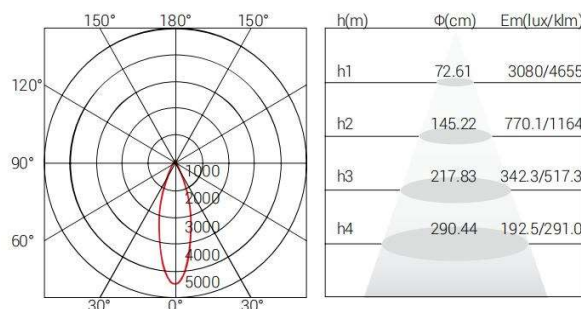

Finishing Color

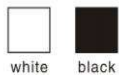

Model Code	AK-10W
Power	10W
Size:	95*95*H94mm
Cut out	Φ85mm
Light Source	Luminus / CREE
Optical	Lens

UGR	<18
Flicker	<15%
Beam angle	18° / 24° / 36°

CCT	3000K/4000K/6000K
Lumens	800lm
Power Factor	0.95
Efficiency	80%
Lifespan	50000h
Input Voltage	AC85-265V
IP	20
Driver	Eaglerise / Philips / Lifud
Material	Aluminium

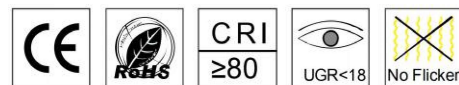
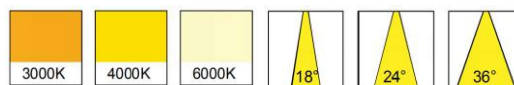
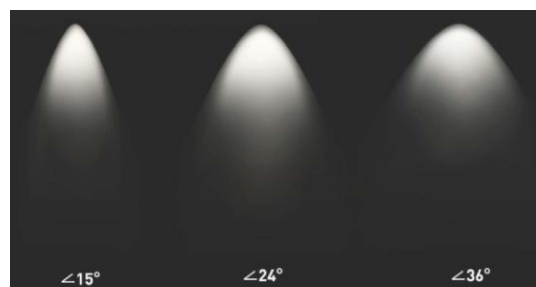
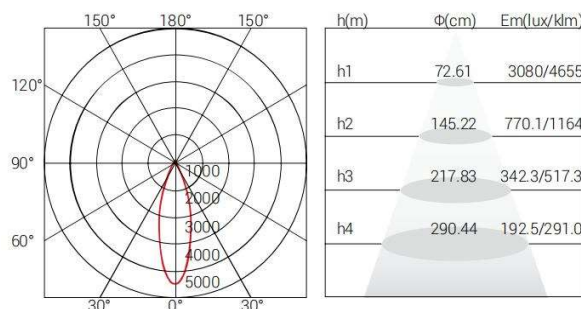

Finishing Color

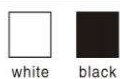

Model Code	AY-10W
Power	10W
Size:	Φ95*H94mm
Cut out	Φ85mm
Light Source	Luminus / CREE
Optical	Lens

UGR	<18
Flicker	<15%
Beam angle	18° / 24° / 36°

CCT	3000K/4000K/6000K
Lumens	800lm
Power Factor	0.95
Efficiency	80%
Lifespan	50000h
Input Voltage	AC85-265V
IP	20
Driver	Eaglerise / Philips / Lifud
Material	Aluminium



Model Code	X12B	UGR	<19	Input Voltage	AC85-265V
Power	12W	Flicker	<15%	Driver	Eaglerise /Lifud
Size:	Φ90*H120mm	Beam angle	18°/ 24°/ 36°	IP	20
Cut out	Φ80mm	CCT	3000K/4000K/6000K	Material	Aluminium
Light Source	Luminus / CREE	Power Factor	0.95	Lifespan	50000h
Optical	Lens	Efficiency	80%		

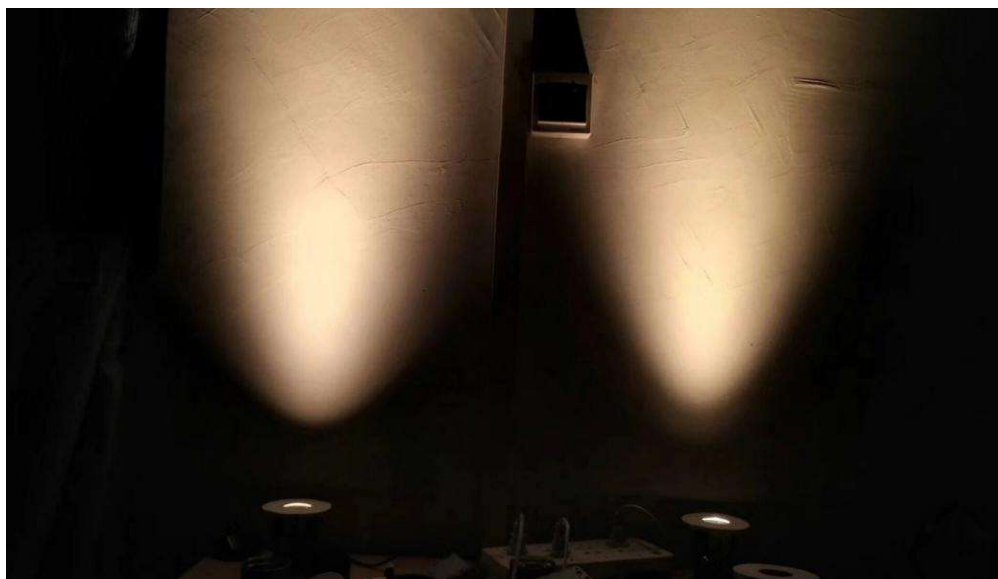



Model Code	302	UGR	<19	Input Voltage	AC85-265V
Power	12W	Flicker	<15%	Driver	Eaglerise /Lifud
Size:	Φ85*H67mm	Beam angle	18°/ 24°/ 36°	IP	20
Cut out	Φ75mm	CCT	3000K/4000K/6000K	Material	Aluminium
Light Source	Luminus / CREE	Power Factor	0.95	Lifespan	50000h
Optical	Lens	Efficiency	80%		



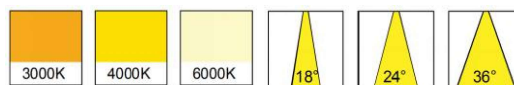
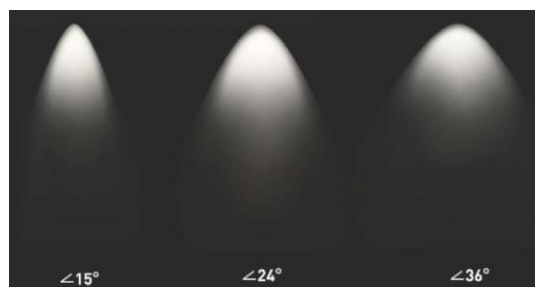
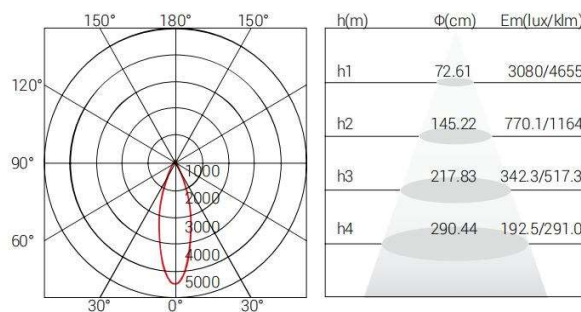

Model Code	S303 / S304
Power	12W / 20W
Size:	90*H100mm / 125*H135mm
Cut out	80*80 / 110*110mm
Light Source	Luminus / CREE
Optical	Lens

UGR	<18
Flicker	<15%
Beam angle	12°, 24°, 38°

CCT	3000K/4000K/6000K
Lumens	120lm / W
Power Factor	0.95
Efficiency	80%
Lifespan	50000h
Input Voltage	AC85-265V
IP	20
Driver	Eaglerise / Philips / Lifud
Material	Aluminium

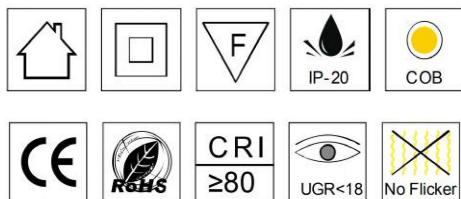

Finishing Color

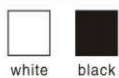

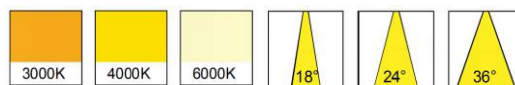
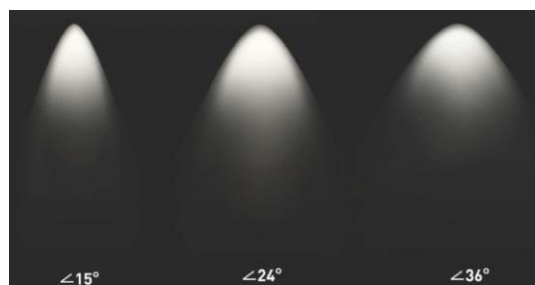
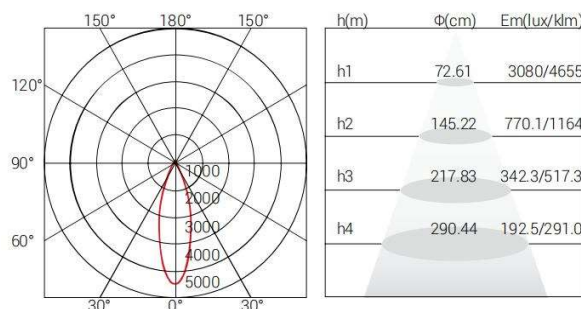

Model Code	305
Power	12W
Size:	100*100*H90mm
Cut out	95*95mm
Light Source	Luminus / CREE
Optical	Lens

UGR	<18
Fliker<15%	√
Beam angle	12°, 24°, 38°

CCT	3000K/4000K/6000K
Lumens	120lm / W
Power Factor	0.95
Efficiency	80%
Lifespan	50000h
Input Voltage	AC85-265V
IP	20
Driver	Eaglerise / Philips / Lifud
Material	Aluminium

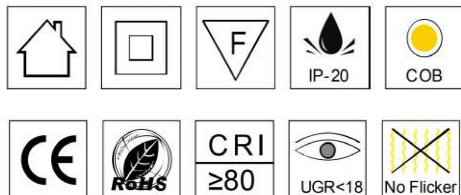

Finishing Color

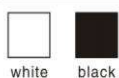

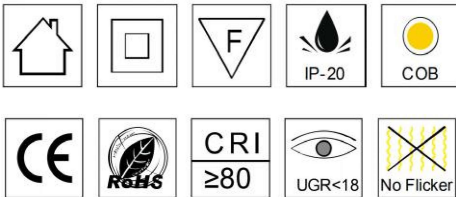
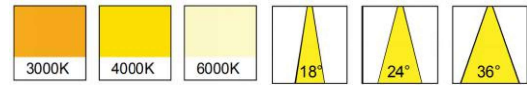
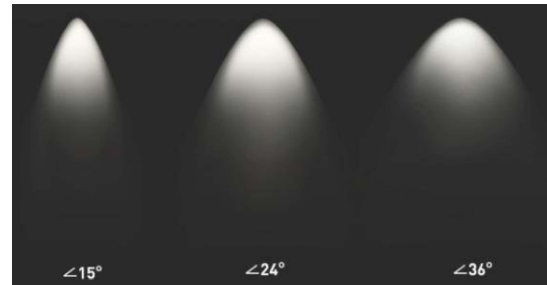
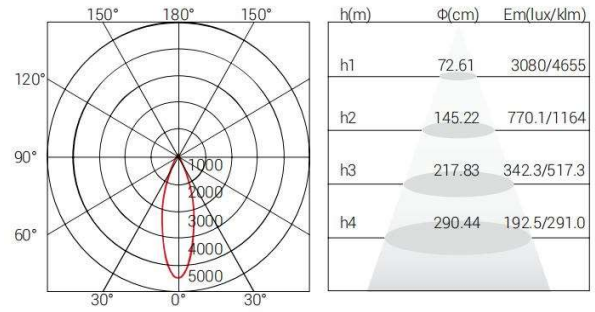

Finishing Color

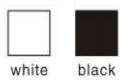

Model Code	306
Power	12W
Size:	Φ85*90mm
Cut out	Φ80mm
Light Source	Luminus / CREE
Optical	Lens

UGR	<18
Flicker	<15%
Beam angle	12°, 24°, 38°

CCT	3000K/4000K/6000K
Lumens	120lm / W
Power Factor	0.95
Efficiency	80%
Lifespan	50000h
Input Voltage	AC85-265V
IP	20
Driver	Eaglerise / Philips / Lifud
Material	Aluminium

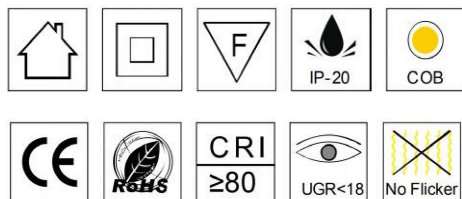
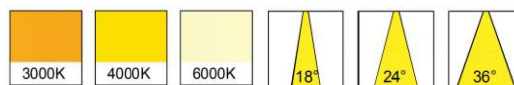
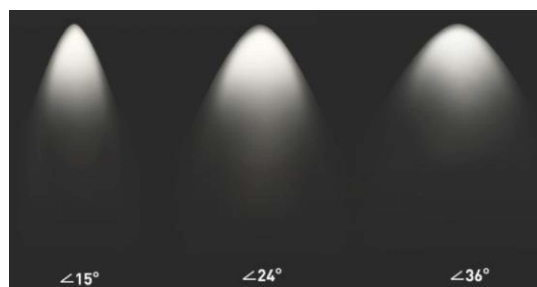
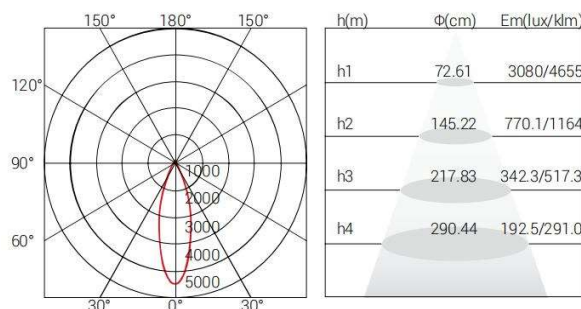

Model Code	307
Power	7W
Size:	Φ77*84mm
Cut out	Φ65mm
Light Source	Luminus / CREE
Optical	Lens

UGR	<18
Flicker	<15%
Beam angle	12°, 24°, 38°

CCT	3000K/4000K/6000K
Lumens	120lm / W
Power Factor	0.95
Efficiency	80%
Lifespan	50000h
Input Voltage	AC85-265V
IP	20
Driver	Eaglerise / Philips / Lifud
Material	Aluminium

Finishing Color

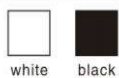

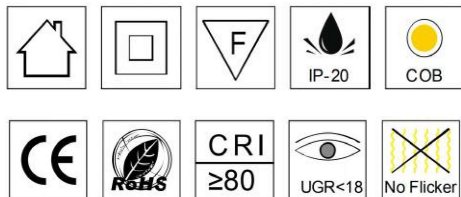
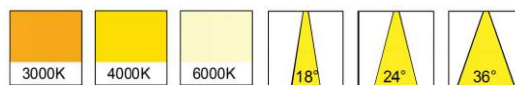
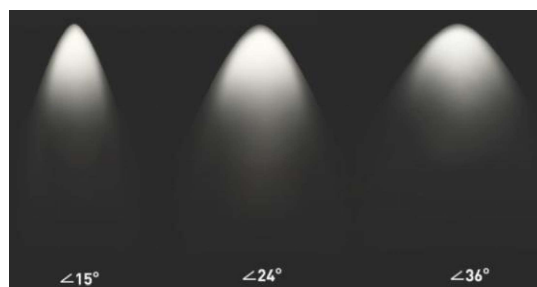
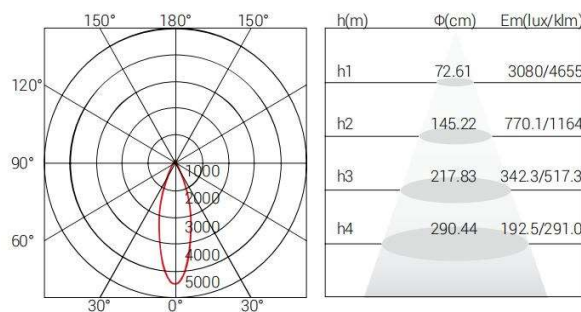
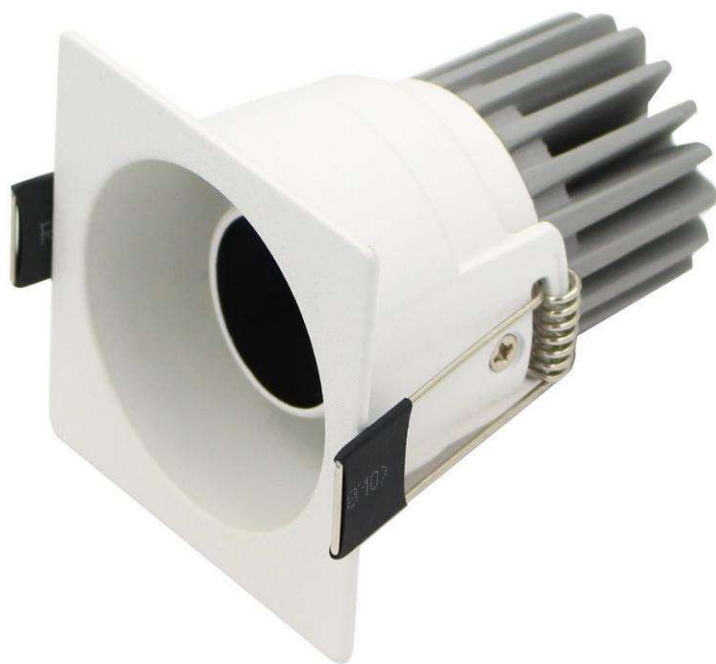

Finishing Color

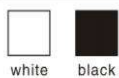

Model Code	309
Power	7W
Size:	65*65*90mm
Cut out	Φ60mm
Light Source	Luminus / CREE
Optical	Lens

UGR	<18
Fliker<15%	√
Beam angle	12°, 24°, 38°

CCT	3000K/4000K/6000K
Lumens	120lm / W
Power Factor	0.95
Efficiency	80%
Lifespan	50000h
Input Voltage	AC85-265V
IP	20
Driver	Eaglerise / Philips / Lifud
Material	Aluminium

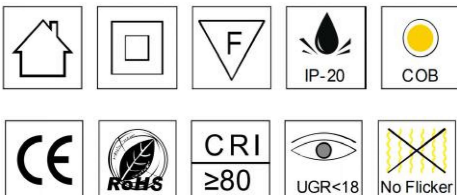
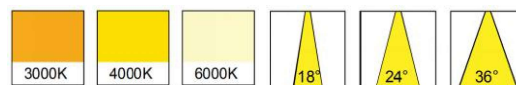
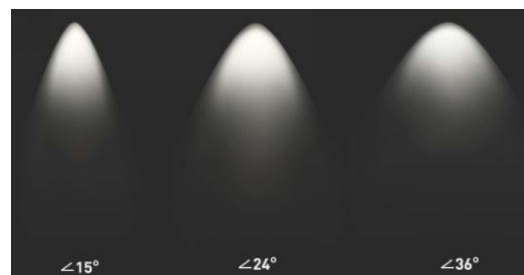
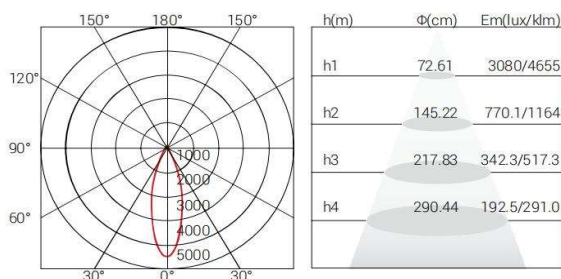

Finishing Color

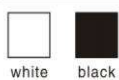

Model Code	311
Power	7W
Size:	Φ72*H78mm
Cut out	Φ65mm
Light Source	Luminus / CREE
Optical	Lens

UGR	<18
Fliker<15%	√
Beam angle	12°, 24°, 38°

CCT	3000K/4000K/6000K
Lumens	120lm / W
Power Factor	0.95
Efficiency	80%
Lifespan	50000h
Input Voltage	AC85-265V
IP	20
Driver	Eaglerise / Philips / Lifud
Material	Aluminium

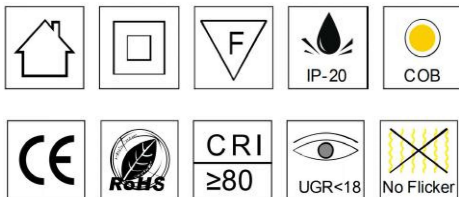
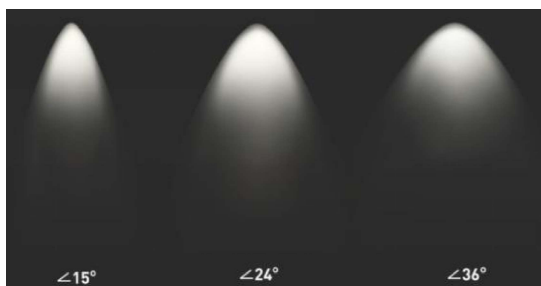
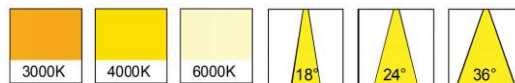
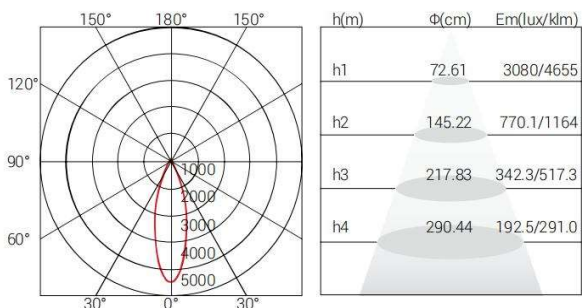

Finishing Color

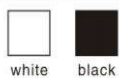

Model Code	312S / 312B
Power	7W / 20W
Size:	72*H78mm / 130*H108mm
Cut out	Φ65/Φ115mm
Light Source	Luminus / CREE
Optical	Lens

UGR	<18
Flicker	<15%
Beam angle	12°, 24°, 38°

CCT	3000K/4000K/6000K
Lumens	120lm / W
Power Factor	0.95
Efficiency	80%
Lifespan	50000h
Input Voltage	AC85-265V
IP	20
Driver	Eaglerise / Philips / Lifud
Material	Aluminium

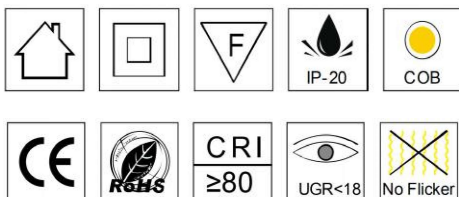
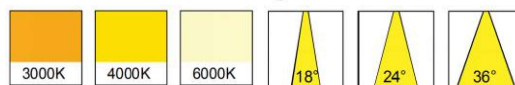
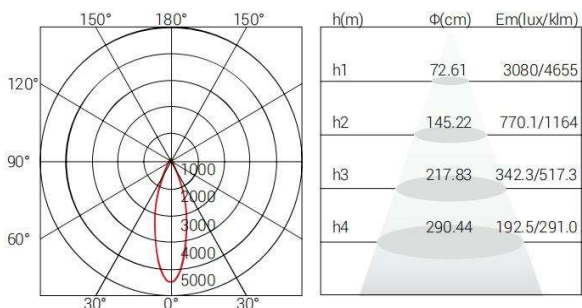

Finishing Color

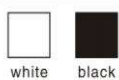

Model Code	309
Power	7W
Size:	65*65*90mm
Cut out	Φ60mm
Light Source	Luminus / CREE
Optical	Lens

UGR	<18
Flicker	<15%
Beam angle	12°, 24°, 38°

CCT	3000K/4000K/6000K
Lumens	120lm / W
Power Factor	0.95
Efficiency	80%
Lifespan	50000h
Input Voltage	AC85-265V
IP	20
Driver	Eaglerise / Philips / Lifud
Material	Aluminium

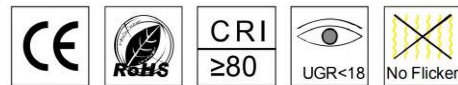
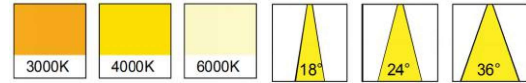
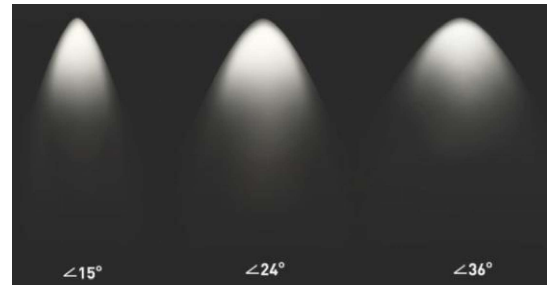
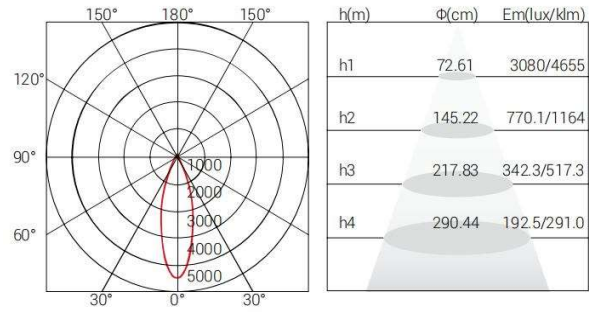

Finishing Color

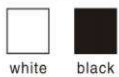

Model Code ZH-H12C

Power 12W

Size: Φ100*H65mm

Cut out Φ90mm

Light Source Luminus / CREE

Optical Lens

UGR < 19

Flicker < 15% ✓

Beam angle 18° / 24° / 36°

CCT 3000K/4000K/6000K

Lumens 960lm

Power Factor 0.95

Efficiency 80%

Lifespan 50000h

Input Voltage AC85-265V

IP 20

Driver Eaglerise / Philips / Lifud

Material Aluminium

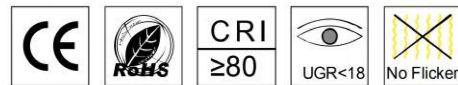
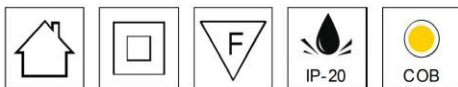
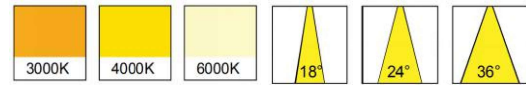
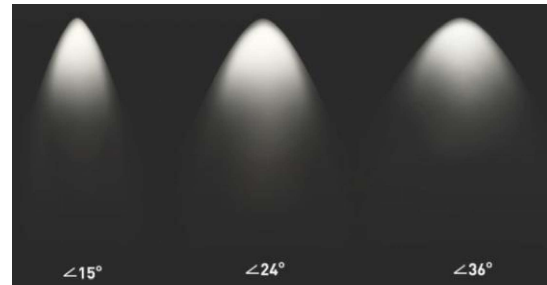
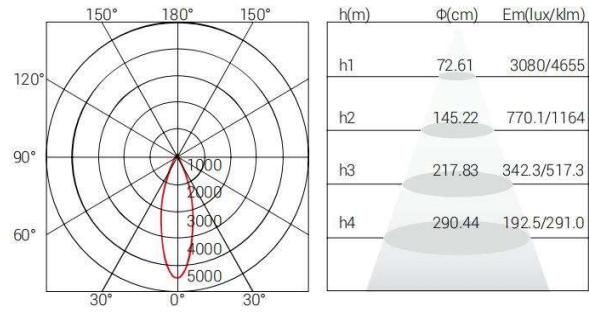

Finishing Color

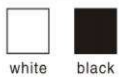

Model Code	T-12K
Power	12W
Size:	Φ73*H118mm
Cut out	Φ65mm
Light Source	Luminus / CREE
Optical	Lens

UGR	<22
Flicker	<15%
Beam angle	18° / 24° / 36°

CCT	3000K/4000K/6000K
Lumens	960lm
Power Factor	0.95
Efficiency	80%
Lifespan	50000h
Input Voltage	AC85-265V
IP	20
Driver	Eaglerise / Philips / Lifud
Material	Aluminium

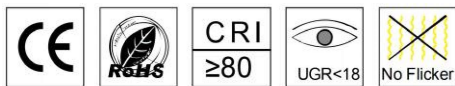
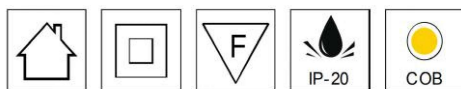
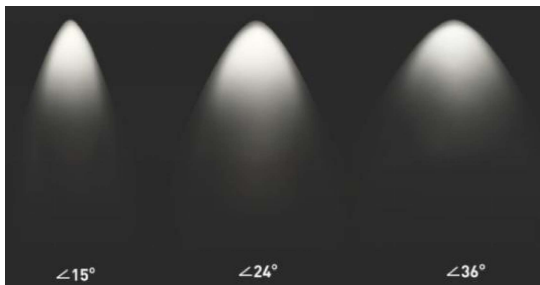

Finishing Color

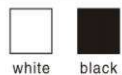

Model Code	Y207
Power	6W
Size:	72*72*110mm
Cut out	Φ65mm
Light Source	Luminus / CREE
Optical	Lens

UGR	<22
Flicker	<15%
Beam angle	18° / 24° / 36°

CCT	3000K/4000K/6000K
Lumens	560lm
Power Factor	0.95
Efficiency	80%
Lifespan	50000h
Input Voltage	AC85-265V
IP	20
Driver	Eaglerise / Philips / Lifud
Material	Aluminium

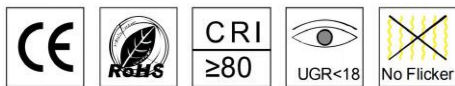
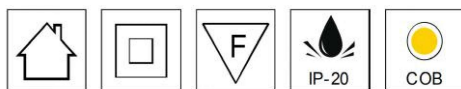
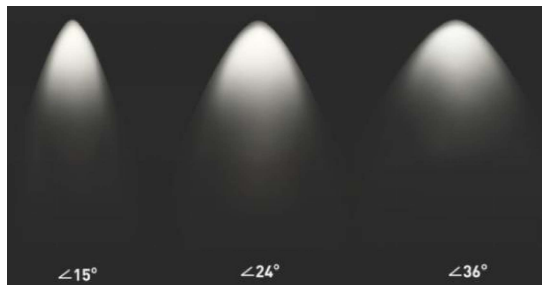

Finishing Color

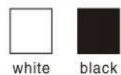

Model Code	Y214
Power	12W
Size:	132*72*110mm
Cut out	120*65mm
Light Source	Luminus / CREE
Optical	Lens

UGR	<22
Flicker	<15%
Beam angle	18° / 24° / 36°

CCT	3000K/4000K/6000K
Lumens	960lm
Power Factor	0.95
Efficiency	80%
Lifespan	50000h
Input Voltage	AC85-265V
IP	20
Driver	Eaglerise / Philips / Lifud
Material	Aluminium

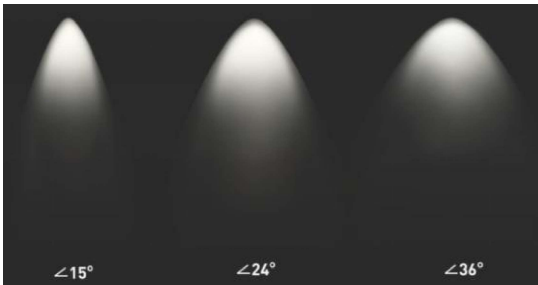

Finishing Color

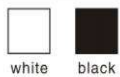

Model Code	Y221
Power	12W
Size:	135*72*110mm
Cut out	125*72mm
Light Source	Luminus / CREE
Optical	Lens

UGR	<22
Flicker	<15%
Beam angle	18° / 24° / 36°

CCT	3000K/4000K/6000K
Lumens	1450lm
Power Factor	0.95
Efficiency	80%
Lifespan	50000h
Input Voltage	AC85-265V
IP	20
Driver	Eaglerise / Philips / Lifud
Material	Aluminium

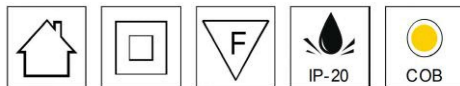
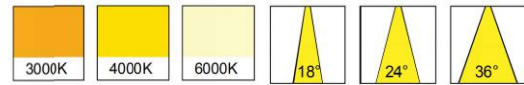
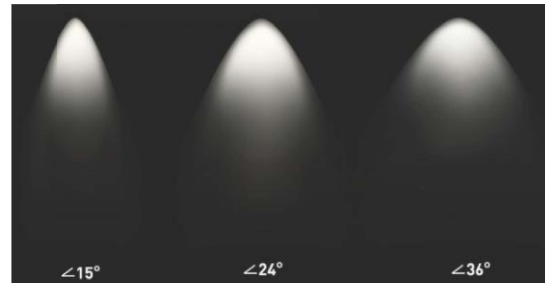
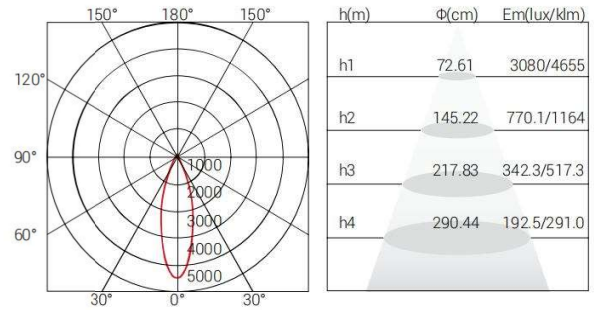
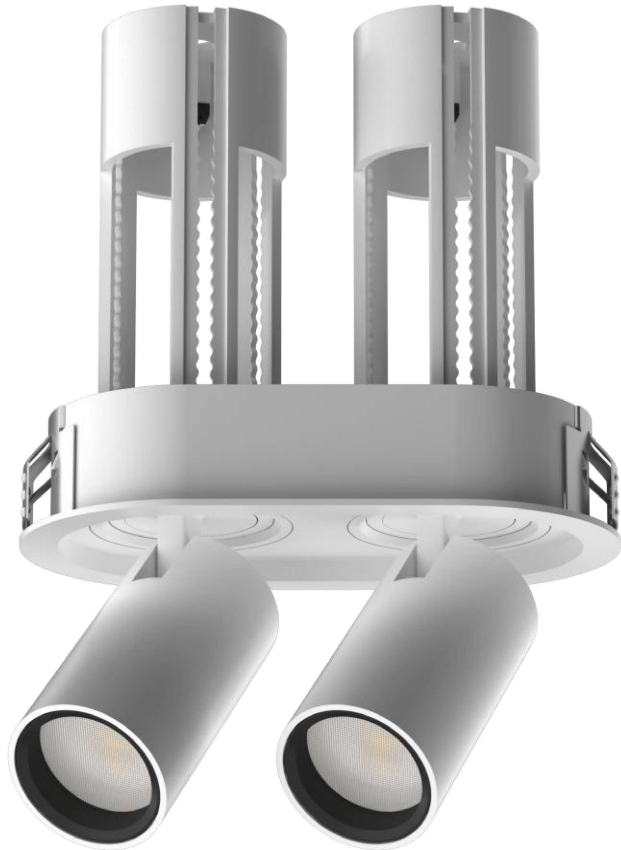

Finishing Color

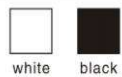

Model Code	SR-S12
Power	12W
Size:	Φ140*80*H81mm
Cut out	Φ130*60mm
Light Source	Luminus / CREE
Optical	Lens

UGR	<22
Flicker<15%	√
Beam angle	18° / 24° / 36°

CCT	3000K/4000K/6000K
Lumens	960lm
Power Factor	0.95
Efficiency	80%
Lifespan	50000h
Input Voltage	AC85-265V
IP	20
Driver	Eaglerise / Philips / Lifud
Material	Aluminium

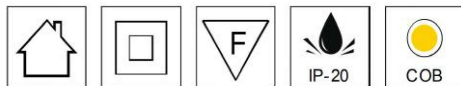
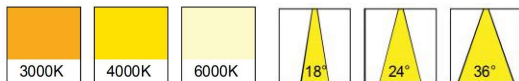

Finishing Color

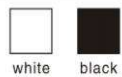

Model Code	SR-S18
Power	18W
Size:	Φ234*68*H81mm
Cut out	Φ188*68mm
Light Source	Luminus / CREE
Optical	Lens

UGR	<22
Flicker	<15%
Beam angle	18° / 24° / 36°

CCT	3000K/4000K/6000K
Lumens	1450lm
Power Factor	0.95
Efficiency	80%
Lifespan	50000h
Input Voltage	AC85-265V
IP	20
Driver	Eaglerise / Philips / Lifud
Material	Aluminium

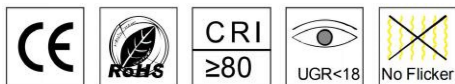
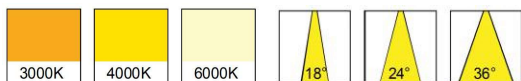

Finishing Color

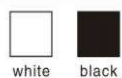

Model Code	SR-S24
Power	24W
Size:	Φ140*140*H81mm
Cut out	Φ130*130mm
Light Source	Luminus / CREE
Optical	Lens

UGR	<22
Flicker<15%	√
Beam angle	18° / 24° / 36°

CCT	3000K/4000K/6000K
Lumens	1950lm
Power Factor	0.95
Efficiency	80%
Lifespan	50000h
Input Voltage	AC85-265V
IP	20
Driver	Eaglerise / Philips / Lifud
Material	Aluminium

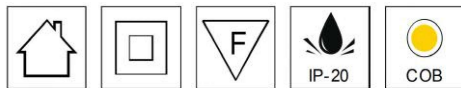
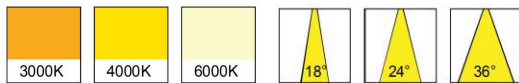
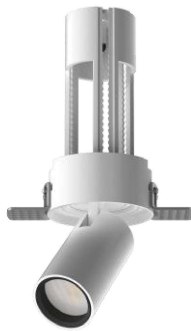

Finishing Color

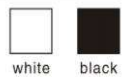

Model Code	SM-T06, SM-T12, SM-T18, SM-T24
Power	6W / 12W / 18W / 24W
Size:	Φ80*H81mm / Φ140*80*H8mm Φ234*68*H81mm / Φ140*140*H81mm

Light Source	Luminus / CREE
Optical	Lens

UGR	<22
Flicker<15%	√
Beam angle	18° / 24° / 36°

CCT	3000K/4000K/6000K
Lumens	120lm / W
Power Factor	0.95
Efficiency	80%
Lifespan	50000h
Input Voltage	AC85-265V
IP	20
Driver	Eaglerise / Philips / Lifud
Material	Aluminium

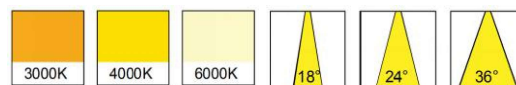
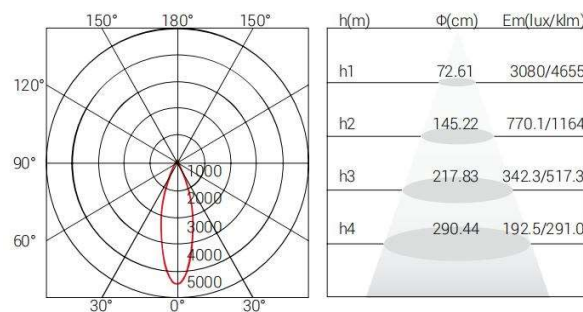

Model Code	T-12R / T-25R
Power	12W / 25W
Size:	Φ98*H120mm / Φ130*H1135mm
Cut out	Φ90mm / Φ125mm
Light Source	Luminus / CREE
Optical	Lens

UGR	<22
Flicker<15%	√
Beam angle	18° / 24° / 36°

CCT	3000K/4000K/6000K
Lumens	120lm / W
Power Factor	0.95
Efficiency	80%
Lifespan	50000h
Input Voltage	AC85-265V
IP	20
Driver	Eaglerise / Philips / Lifud
Material	Aluminium

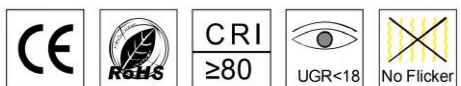

Finishing Color

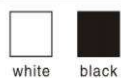

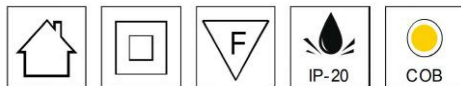
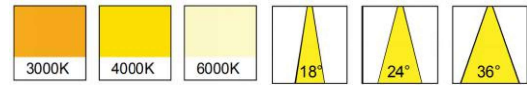
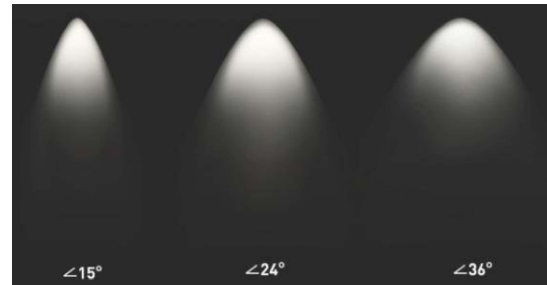
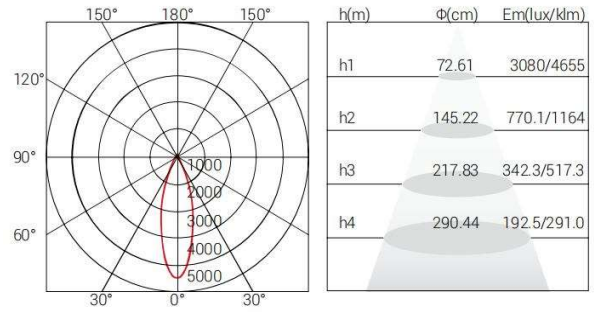

Model Code	T-12C / T-25C
Power	12W / 25W
Size:	100*100*H120mm / 130*130*H135mm
Cut out	Φ90mm / Φ125mm
Light Source	Luminus / CREE
Optical	Lens

UGR	<22
Flicker<15%	√
Beam angle	18° / 24° / 36°

CCT	3000K/4000K/6000K
Lumens	120lm / W
Power Factor	0.95
Efficiency	80%
Lifespan	50000h
Input Voltage	AC85-265V
IP	20
Driver	Eaglerise / Philips / Lifud
Material	Aluminium

Finishing Color

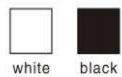

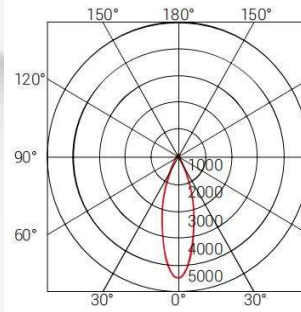

h(m)	Φ(cm)	Em(lux/klm)
h1	72.61	3080/4655
h2	145.22	770.1/1164
h3	217.83	342.3/517.3
h4	290.44	192.5/291.0

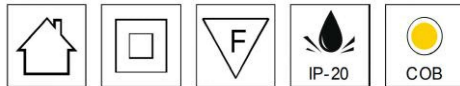
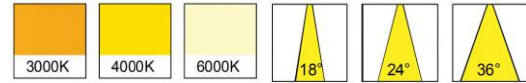
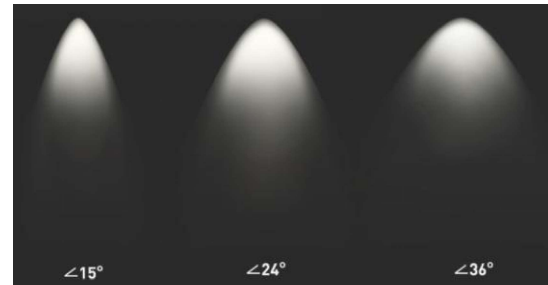

Finishing Color

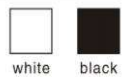

Model Code	T-12H / T-25H
Power	12*2= 24W / 25*2= 50W
Size:	100*185*H120mm / 130*240*H135mm
Cut out	175*90mm / 230*120mm
Light Source	Luminus / CREE
Optical	Lens

UGR	<22
Flicker	<15%
Beam angle	18° / 24° / 36°

CCT	3000K/4000K/6000K
Lumens	120lm / W
Power Factor	0.95
Efficiency	80%
Lifespan	50000h
Input Voltage	AC85-265V
IP	20
Driver	Eaglerise / Philips / Lifud
Material	Aluminium

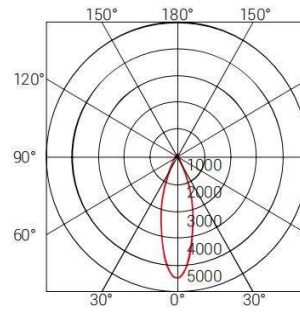

h(m)	Φ(cm)	Em(lux/klm)
h1	72.61	3080/4655
h2	145.22	770.1/1164
h3	217.83	342.3/517.3
h4	290.44	192.5/291.0

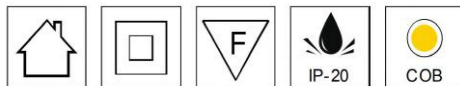
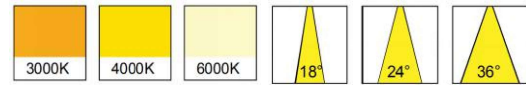
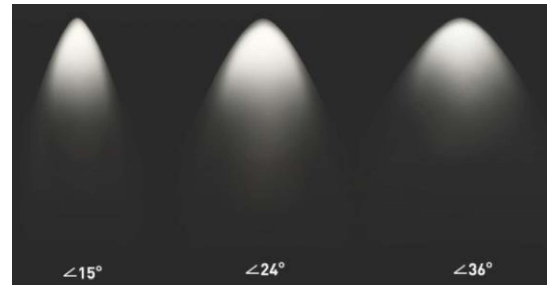

Finishing Color

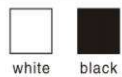

Model Code	T-12X3S , T-25X3S
Power	12*3= 36W / 25*3= 75W
Size:	100*270*H120mm / 130*345*H135mm
Cut out	260*90mm / 330*120mm
Light Source	Luminus / CREE
Optical	Lens

UGR	<22
Flicker<15%	√
Beam angle	18° / 24° / 36°

CCT	3000K/4000K/6000K
Lumens	120lm / W
Power Factor	0.95
Efficiency	80%
Lifespan	50000h
Input Voltage	AC85-265V
IP	20
Driver	Eaglerise / Philips / Lifud
Material	Aluminium

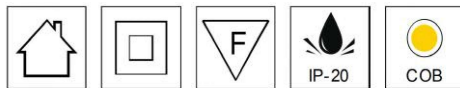
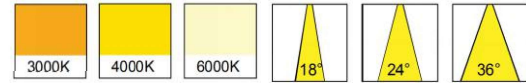
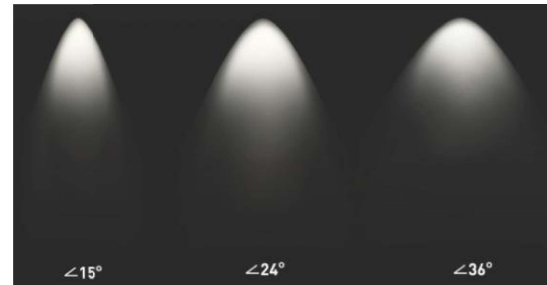
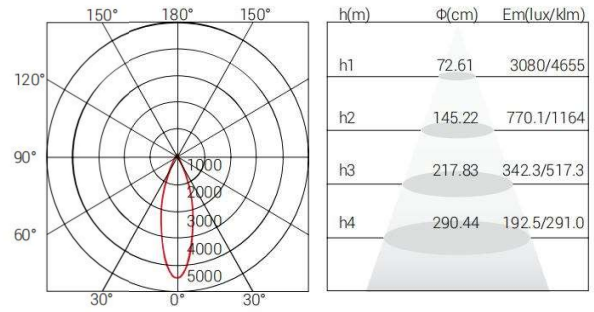

Finishing Color

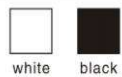

Model Code	T-12G,T-25G
Power	12*2= 24W / 25*2= 50W
Size:	100*185*H120mm / 130*240*H135mm
Cut out	175*90mm / 230*120mm
Light Source	Luminus / CREE
Optical	Lens

UGR	<22
Fliker<15%	√
Beam angle	18° / 24°/36°

CCT	3000K/4000K/6000K
Lumens	120lm / W
Power Factor	0.95
Efficiency	80%
Lifespan	50000h
Input Voltage	AC85-265V
IP	20
Driver	Eaglerise / Philips / Lifud
Material	Aluminium

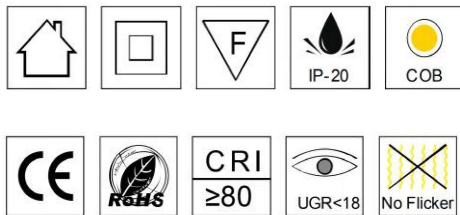
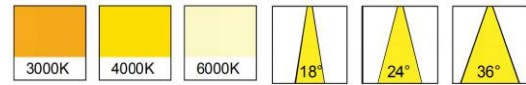
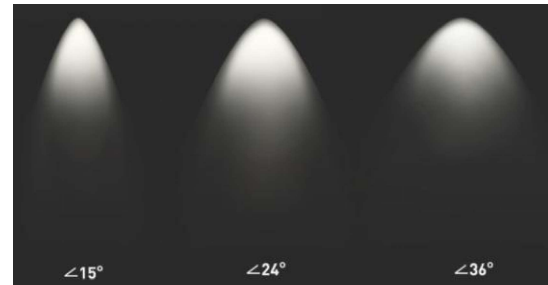
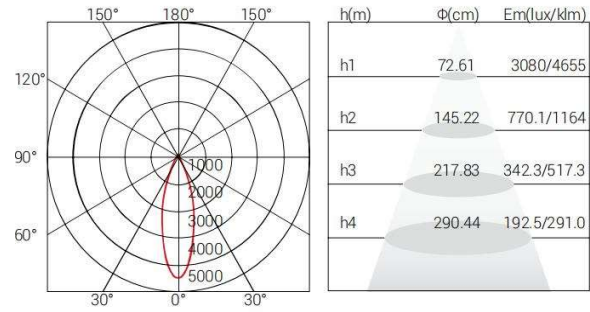

Finishing Color

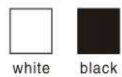

Model Code	T-12X3F, T-25X3F
Power	12*3= 36W / 25*3= 75W
Size:	100*270*H120mm / 130*345*H135mm
Cut out	260*90mm / 330*120mm
Light Source	Luminus / CREE
Optical	Lens

UGR	<22
Flicker<15%	√
Beam angle	18° / 24° / 36°

CCT	3000K/4000K/6000K
Lumens	120lm / W
Power Factor	0.95
Efficiency	80%
Lifespan	50000h
Input Voltage	AC85-265V
IP	20
Driver	Eaglerise / Philips / Lifud
Material	Aluminium



Model Code	RH10	RH20	RH30
Power	10W	20W	30W
Size:	97*97mm	167*97mm	237*97mm
Cut out	75*75mm	145*75mm	215*75mm
Light Source	Luminus / CREE	Luminus / CREE	Luminus / CREE
Optical	Reflector	Reflector	Reflector
UGR	<22	<22	<22
Fliker<15%	√	√	√
Beam angle	15°/ 30°/45°	15°/ 30°/45°	15°/ 30°/45°
CCT	3000K/4000K/6000K		
Power Factor	0.95	0.95	0.95
Efficiency	80%	80%	80%
Input Voltage	AC85-265V	AC85-265V	AC85-265V
Driver	Eaglerise /Lifud	Eaglerise /Lifud	Eaglerise /Lifud
IP	20	20	20
Material	Aluminium	Aluminium	Aluminium
Lifespan	50000h	50000h	50000h

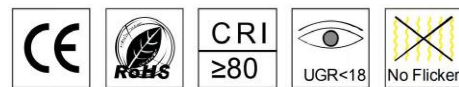
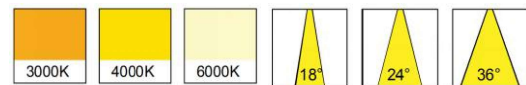
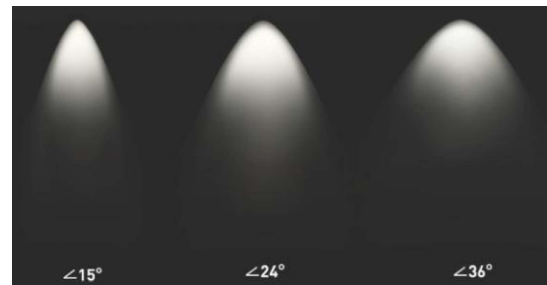
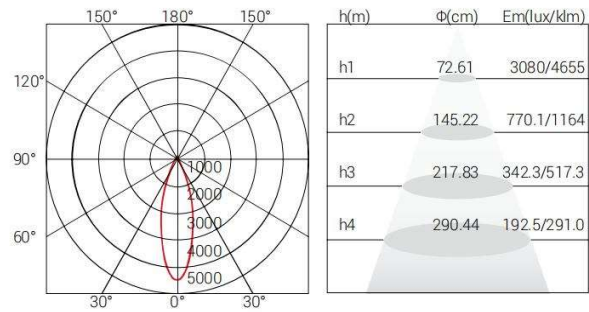

Finishing Color

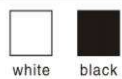

Model Code	DS12
Power	12W
Size:	145*145*H140mm
Cut out	120*120mm
Light Source	Luminus / CREE
Optical	Lens

UGR	<18
Flicker	<15%
Beam angle	18° / 24° / 36°

CCT	3000K/4000K/6000K
Lumens	960lm
Power Factor	0.95
Efficiency	80%
Lifespan	50000h
Input Voltage	AC85-265V
IP	20
Driver	Eaglerise / Philips / Lifud
Material	Aluminium

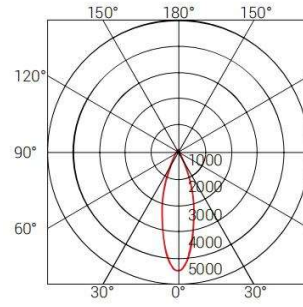

h(m)	Φ(cm)	Em(lux/klm)
h1	72.61	3080/4655
h2	145.22	770.1/1164
h3	217.83	342.3/517.3
h4	290.44	192.5/291.0

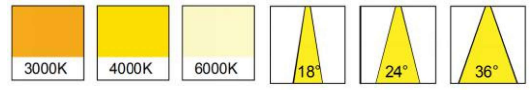
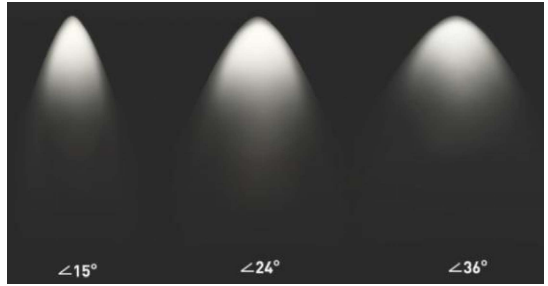

Finishing Color

white black

Model Code DS12

Power 12*2W (24W)

Size: 145*145*H140mm

Cut out 120*120mm

Light Source Luminus / CREE

Optical Lens

UGR < 18

Flicker < 15% ✓

Beam angle 18° / 24° / 36°

CCT 3000K/4000K/6000K

Lumens 1950lm

Power Factor 0.95

Efficiency 80%

Lifespan 50000h

Input Voltage AC85-265V

IP 20

Driver Eaglerise / Philips / Lifud

Material Aluminium

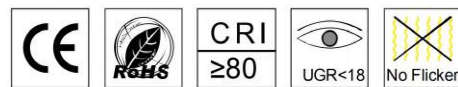
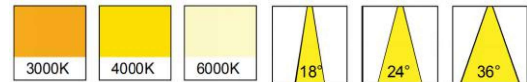
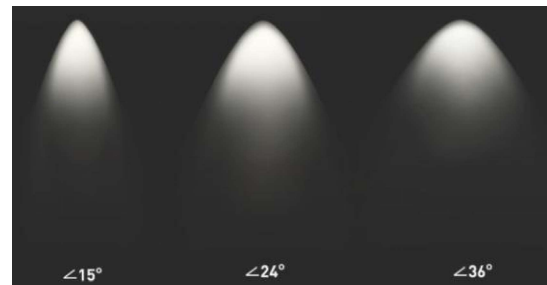
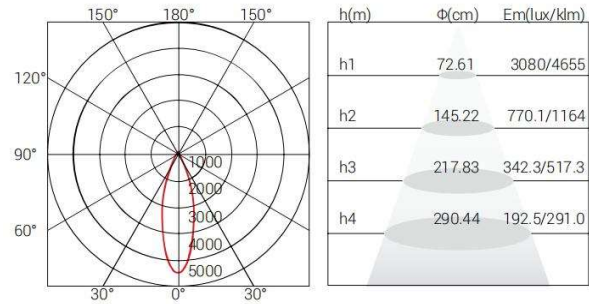

Finishing Color

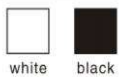

Model Code	DS24
Power	12*2W (24W)
Size:	145*145*H140mm
Cut out	120*120mm
Light Source	Luminus / CREE
Optical	Lens
UGR	<18
Fliker<15%	√
Beam angle	18° / 24° / 36°
CCT	3000K/4000K/6000K
Lumens	1950lm
Power Factor	0.95
Efficiency	80%
Lifespan	50000h
Input Voltage	AC85-265V
IP	20
Driver	Eaglerise / Philips / Lifud
Material	Aluminium

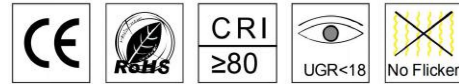

Finishing Color

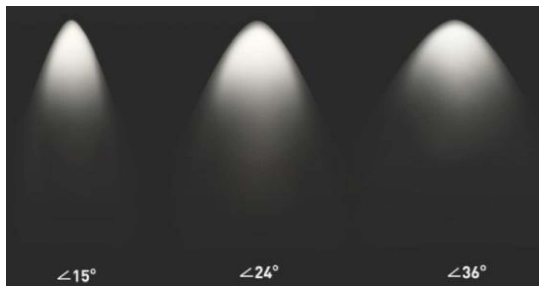
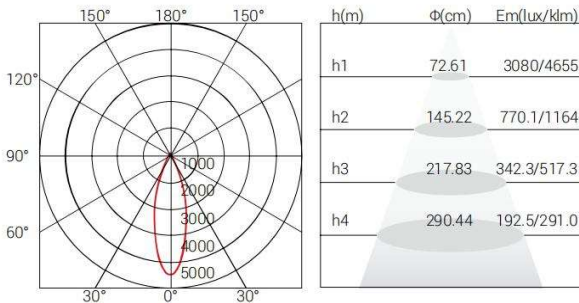
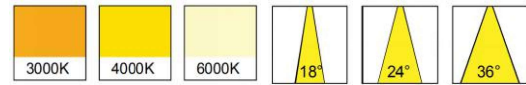
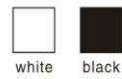

Model Code	H12R
Power	15W
Size:	145*145*H140mm
Cut out	Φ95mm
Light Source	Luminus / CREE
Optical	Lens
UGR	<18
Flicker	<15% ✓
Beam angle	18° / 24° / 36°

CCT	3000K/4000K/6000K
Lumens	1200lm
Power Factor	0.95
Efficiency	80%
Lifespan	50000h
Input Voltage	AC85-265V
IP	20
Driver	Eaglerise / Philips / Lifud
Material	Aluminium

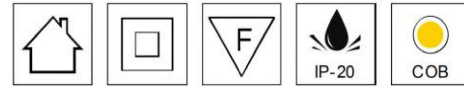

Finishing Color

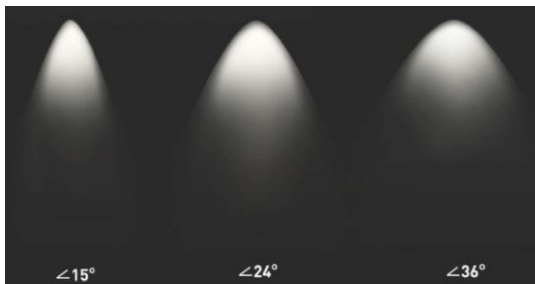
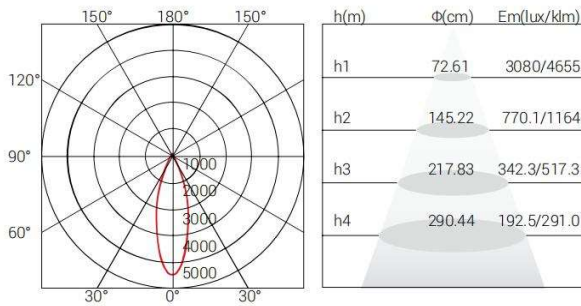
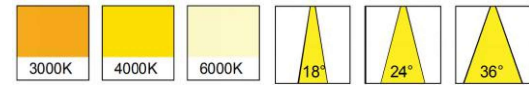
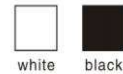

Model Code H111

Power 15W

Size: $\Phi 86 \times 83 \text{mm}$

Cut out $\Phi 75 \text{mm}$

Light Source Luminus / CREE

Optical Lens

UGR < 18

Flicker < 15% ✓

Beam angle $18^\circ / 24^\circ / 36^\circ$

CCT 3000K/4000K/6000K

Lumens 1200lm

Power Factor 0.95

Efficiency 80%

Lifespan 50000h

Input Voltage AC85-265V

IP 20

Driver Eaglerise / Philips / Lifud

Material Aluminium

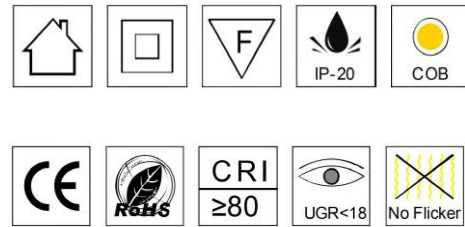

Finishing Color

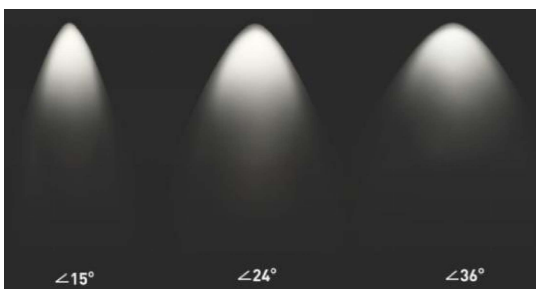
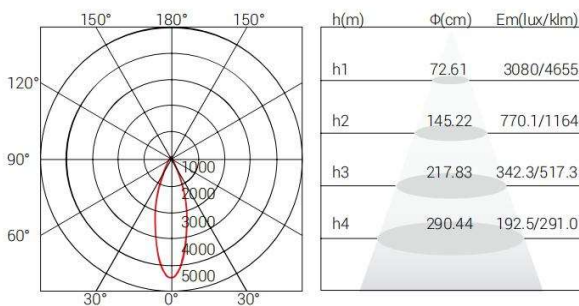
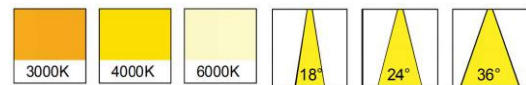
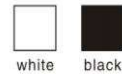

Model Code	H112
Power	15W
Size:	Φ86*83mm
Cut out	Φ75mm
Light Source	Luminus / CREE
Optical	Lens
UGR	<18
Fliker<15%	√
Beam angle	18°/ 24°/36°

CCT	3000K/4000K/6000K
Lumens	1200lm
Power Factor	0.95
Efficiency	80%
Lifespan	50000h
Input Voltage	AC85-265V
IP	20
Driver	Eaglerise / Philips / Lifud
Material	Aluminium

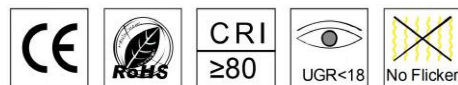
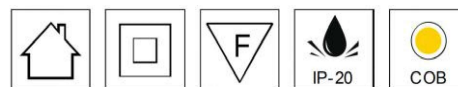

Finishing Color

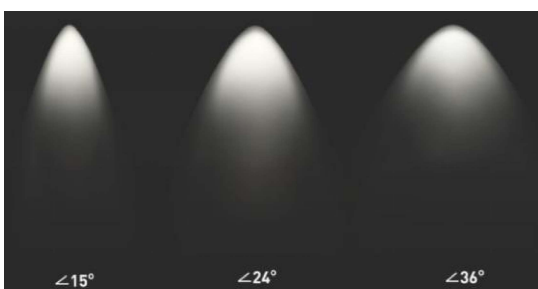
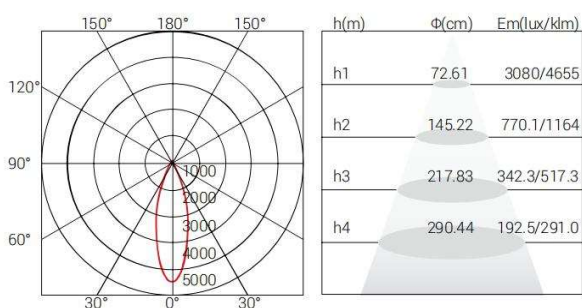
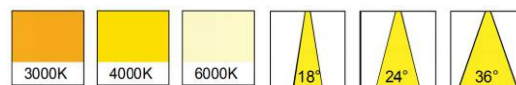
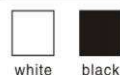

Model Code GS-12

Power 12W

Size: 100*100*95mm

Cut out 85*85mm

Light Source Luminus / CREE

Optical Lens

UGR < 22

Flicker < 15% ✓

Beam angle 18° / 24° / 36°

CCT 3000K/4000K/6000K

Lumens 960lm

Power Factor 0.95

Efficiency 80%

Lifespan 50000h

Input Voltage AC85-265V

IP 20

Driver Eaglerise / Philips / Lifud

Material Aluminium



Finishing Color

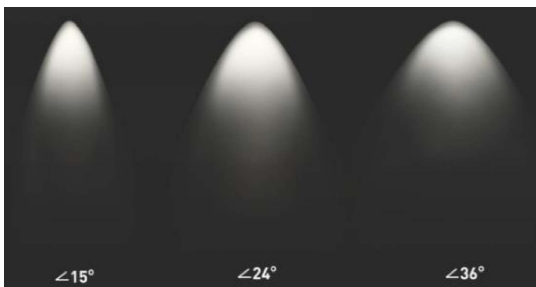
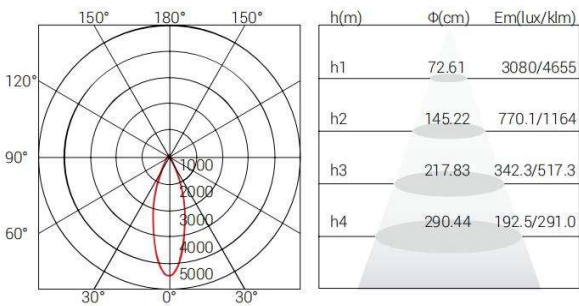
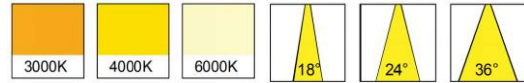
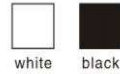

Model Code GS-24

Power 24W

Size: 180*100*95mm

Cut out 160*80mm

Light Source Luminus / CREE

Optical Lens

UGR < 22

Flicker < 15% ✓

Beam angle 18° / 24° / 36°

CCT 3000K/4000K/6000K

Lumens 19200lm

Power Factor 0.95

Efficiency 80%

Lifespan 50000h

Input Voltage AC85-265V

IP 20

Driver Eaglerise / Philips / Lifud

Material Aluminium



Model Code	DR05	DS05	DS10	DS15
Power	5W	5W	10W	15W
Size:	Φ88*H76mm	92*92*76mm	172*92*76mm	252*92*76mm
Cut out	Φ80mm	Φ80mm	Φ165*80mm	Φ240*85mm
Light Source	Luminus / CREE	Luminus / CREE	Luminus / CREE	Luminus / CREE
Optical	Reflector	Reflector	Reflector	Reflector
UGR	<22	<22	<22	<22
Fliker<15%	√	√	√	√
Beam angle	15°/ 30°/45°	15°/ 30°/45°	15°/ 30°/45°	15°/ 30°/45°
CCT	3000K/4000K/6000K			
Power Factor	0.95	0.95	0.95	0.95
Efficiency	80%	80%	80%	80%
Input Voltage	AC85-265V	AC85-265V	AC85-265V	AC85-265V
Driver	Eaglerise /Lifud	Eaglerise /Lifud	Eaglerise /Lifud	Eaglerise /Lifud
IP	20	20	20	20
Material	Aluminium	Aluminium	Aluminium	Aluminium
Lifespan	50000h	50000h	50000h	50000h



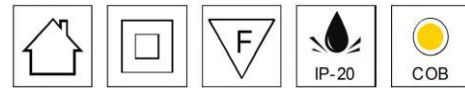

Finishing Color

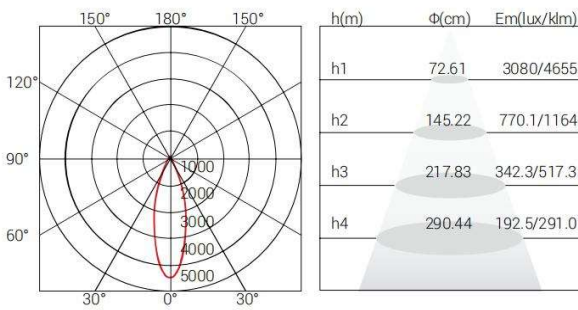
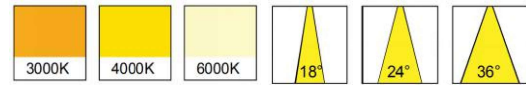
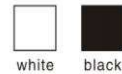

Model Code DT05 / DT09 / DT15 / DT20

Power 5W / 9W / 15W / 20W

Size: Φ60*H71 / Φ82*H100 / Φ98*H129mm

Cut out Φ65mm / Φ85mm / Φ100mm

Light Source Luminus / CREE

Optical Lens

UGR < 18

Flicker < 15% ✓

Beam angle 18° / 24° / 36°

CCT 3000K/4000K/6000K

Lumens 400lm / 720mm / 1200mm / 200lm

Power Factor 0.95

Efficiency 80%

Lifespan 50000h

Input Voltage AC85-265V

IP 20

Driver Eaglrise / Philips / Lifud

Material Aluminium

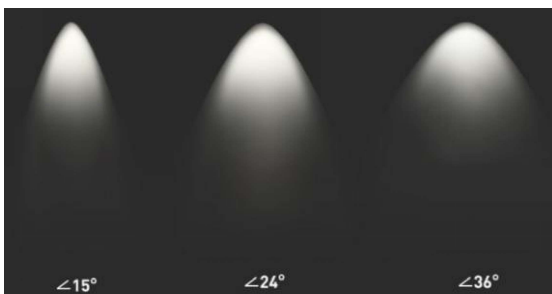

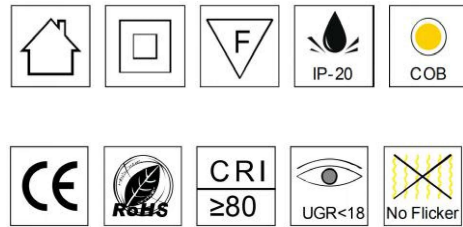

Finishing Color

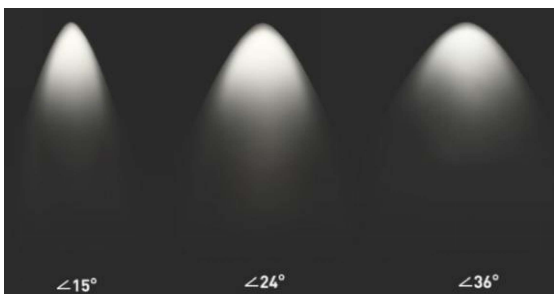
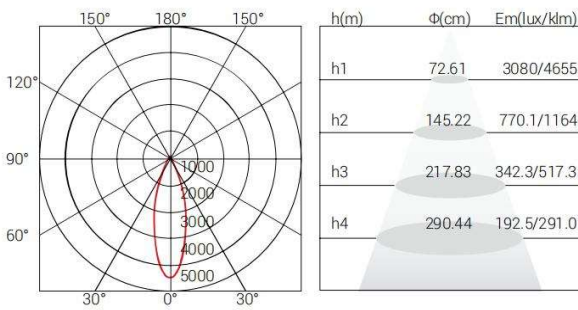
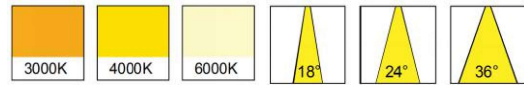
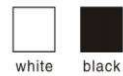

Model Code	DS05 / DS09 / DS15 / DS20
Power	5W / 9W / 15W / 20W
Size:	57*H76 / 73*H100 / 98*H131mm
Cut out	60*60mm / 75*75mm / 100*100mm
Light Source	Luminus / CREE
Optical	Reflector
UGR	<19
Fliker<15%	√
Beam angle	18° / 24° / 36°

CCT	3000K/4000K/6000K
Lumens	400lm / 720mm / 1200mm / 200lm
Power Factor	0.95
Efficiency	80%
Lifespan	50000h
Input Voltage	AC85-265V
IP	20
Driver	Eaglerise / Philips / Lifud
Material	Aluminium

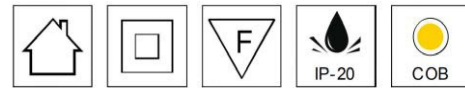

Finishing Color

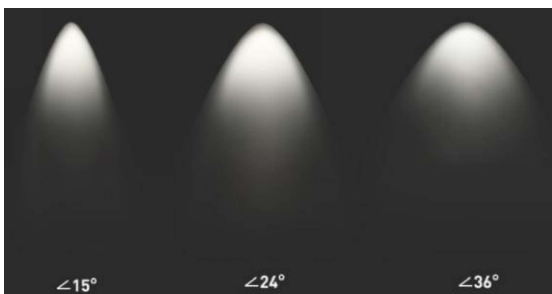
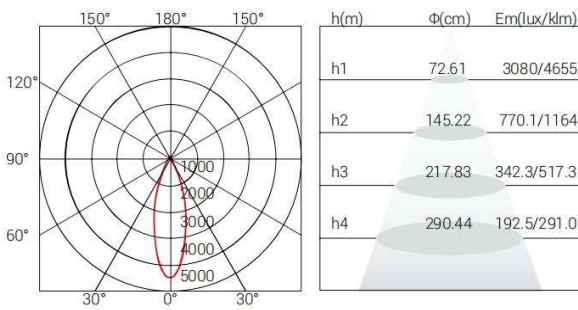
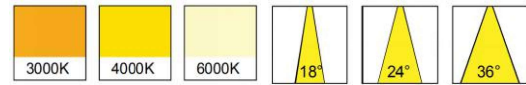
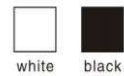

Model Code R507

Power 7W

Size: Φ85*H90mm

Cut out Φ90mm

Light Source Luminus / CREE

Optical Reflector

UGR < 19

Flicker < 15% ✓

Beam angle 18° / 24° / 36°

CCT 3000K/4000K/6000K

Lumens 560lm

Power Factor 0.95

Efficiency 80%

Lifespan 50000h

Input Voltage AC85-265V

IP 20

Driver Eaglrise / Philips / Lifud

Material Aluminium

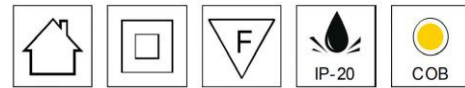

Finishing Color

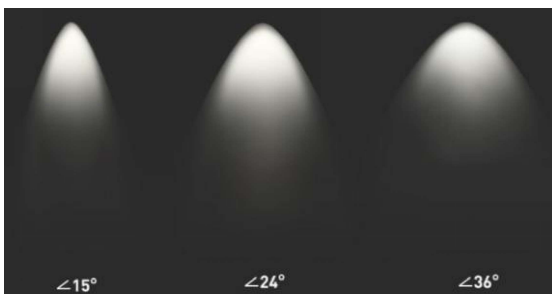
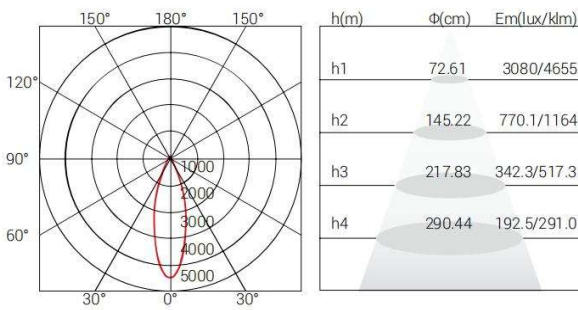
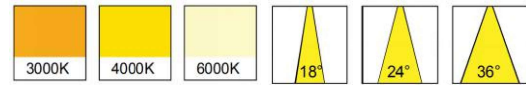
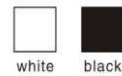

Model Code	S507
Power	7W
Size:	85*85*H90mm
Cut out	90*90mm
Light Source	Luminus / CREE
Optical	Reflector
UGR	<19
Fliker<15%	√
Beam angle	18° / 24° / 36°

CCT	3000K/4000K/6000K
Lumens	560lm
Power Factor	0.95
Efficiency	80%
Lifespan	50000h
Input Voltage	AC85-265V
IP	20
Driver	Eaglerise / Philips / Lifud
Material	Aluminium

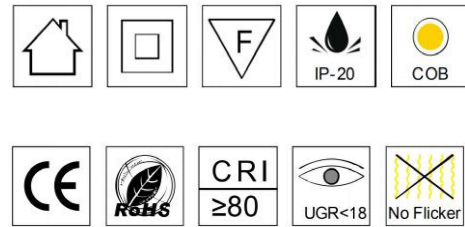

Finishing Color

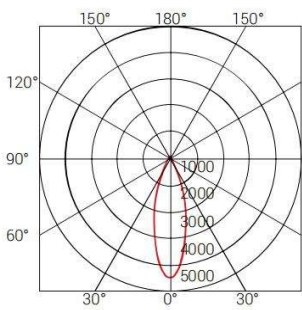
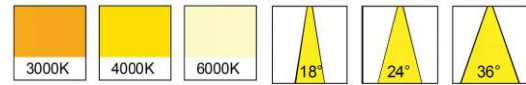
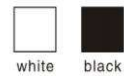

h(m)	Φ(cm)	Em(Lux/klm)
h1	72.61	3080/4655
h2	145.22	770.1/1164
h3	217.83	342.3/517.3
h4	290.44	192.5/291.0

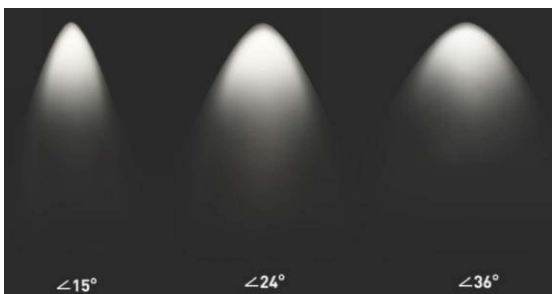

Model Code	R508
Power	9W
Size:	Φ85*H90mm
Cut out	Φ90mm
Light Source	Luminus / CREE
Optical	Reflector
UGR	<19
Fliker<15%	√
Beam angle	18° / 24° / 36°

CCT	3000K/4000K/6000K
Lumens	720lm
Power Factor	0.95
Efficiency	80%
Lifespan	50000h
Input Voltage	AC85-265V
IP	20
Driver	Eaglerise / Philips / Lifud
Material	Aluminium

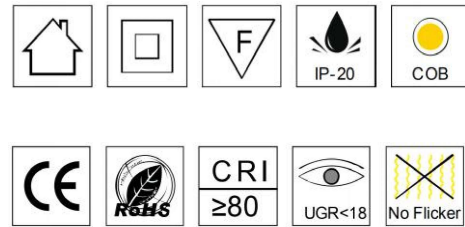

Finishing Color

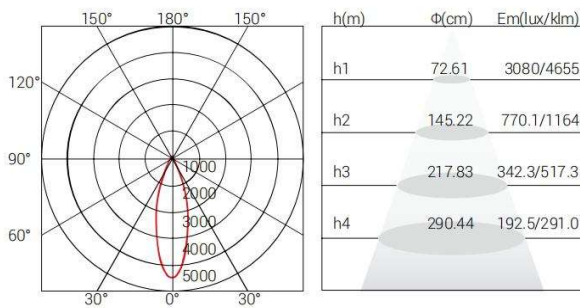
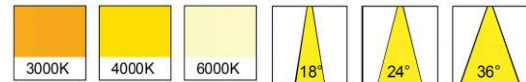
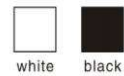

Model Code	S508
Power	9W
Size:	85*85*H90mm
Cut out	Φ90mm
Light Source	Luminus / CREE
Optical	Reflector
UGR	<19
Fliker<15%	√
Beam angle	18° / 24° / 36°

CCT	3000K/4000K/6000K
Lumens	720lm
Power Factor	0.95
Efficiency	80%
Lifespan	50000h
Input Voltage	AC85-265V
IP	20
Driver	Eaglerise / Philips / Lifud
Material	Aluminium

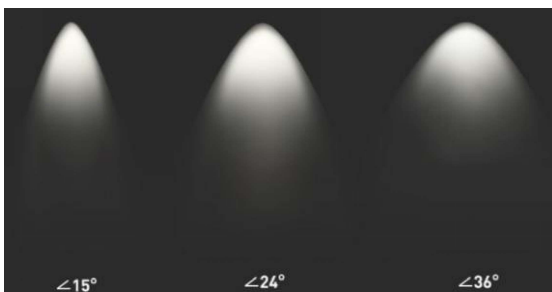



Finishing Color

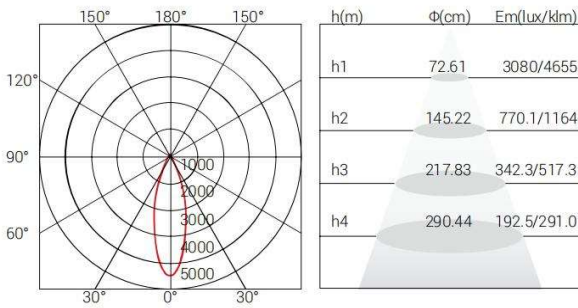
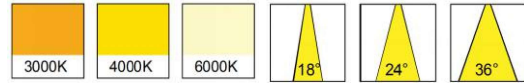
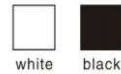

Model Code DK12

Power 12W

Size: Φ108*H120mm

Cut out Φ110mm

Light Source Luminus / CREE

Optical Reflector

UGR < 19

Flicker < 15% ✓

Beam angle 18° / 24° / 36°

CCT 3000K/4000K/6000K

Lumens 960lm

Power Factor 0.95

Efficiency 80%

Lifespan 50000h

Input Voltage AC85-265V

IP 20

Driver Eaglrise / Philips / Lifud

Material Aluminium

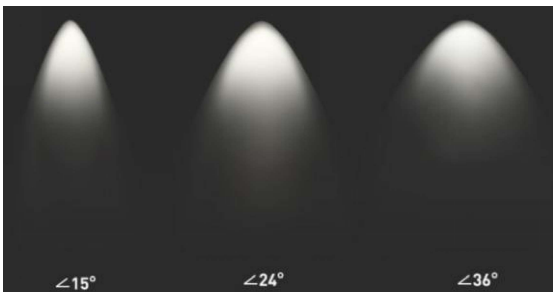



Model Code	XD05	XD10	XD15	XD20	XD30	XD35
Power	5W	10W	15W	20W	30W	35W
Size:	Φ62*H85mm	Φ86*H115mm	Φ110*H140mm	Φ140*H155mm	Φ160*H200mm	Φ180*H210mm
Cut out	Φ55mm	Φ75mm	Φ85mm	Φ125mm	Φ145mm	Φ165mm
Light Source	Luminus / CREE	Luminus / CREE	Luminus / CREE	Luminus / CREE	Luminus / CREE	Luminus / CREE
Optical	Reflector	Reflector	Reflector	Reflector	Reflector	Reflector
UGR	<19	<19	<19	<19	<19	<19
Fliker<15%	√	√	√	√	√	√
Beam angle	18°/ 24°/ 36°	18°/ 24°/ 36°	18°/ 24°/ 36°	18°/ 24°/ 36°	18°/ 24°/ 36°	18°/ 24°/ 36°
CCT	3000K/4000K/6000K					
Power Factor	0.95	0.95	0.95	0.95	0.95	0.95
Efficiency	80%	80%	80%	80%	80%	80%
Input Voltage	AC85-265V	AC85-265V	AC85-265V	AC85-265V	AC85-265V	AC85-265V
Driver	Eaglerise /Lifud	Eaglerise /Lifud	Eaglerise /Lifud	Eaglerise /Lifud	Eaglerise /Lifud	Eaglerise /Lifud
IP	20	20	20	20	20	20
Material	Aluminium	Aluminium	Aluminium	Aluminium	Aluminium	Aluminium
Lifespan	50000h	50000h	50000h	50000h	50000h	50000h

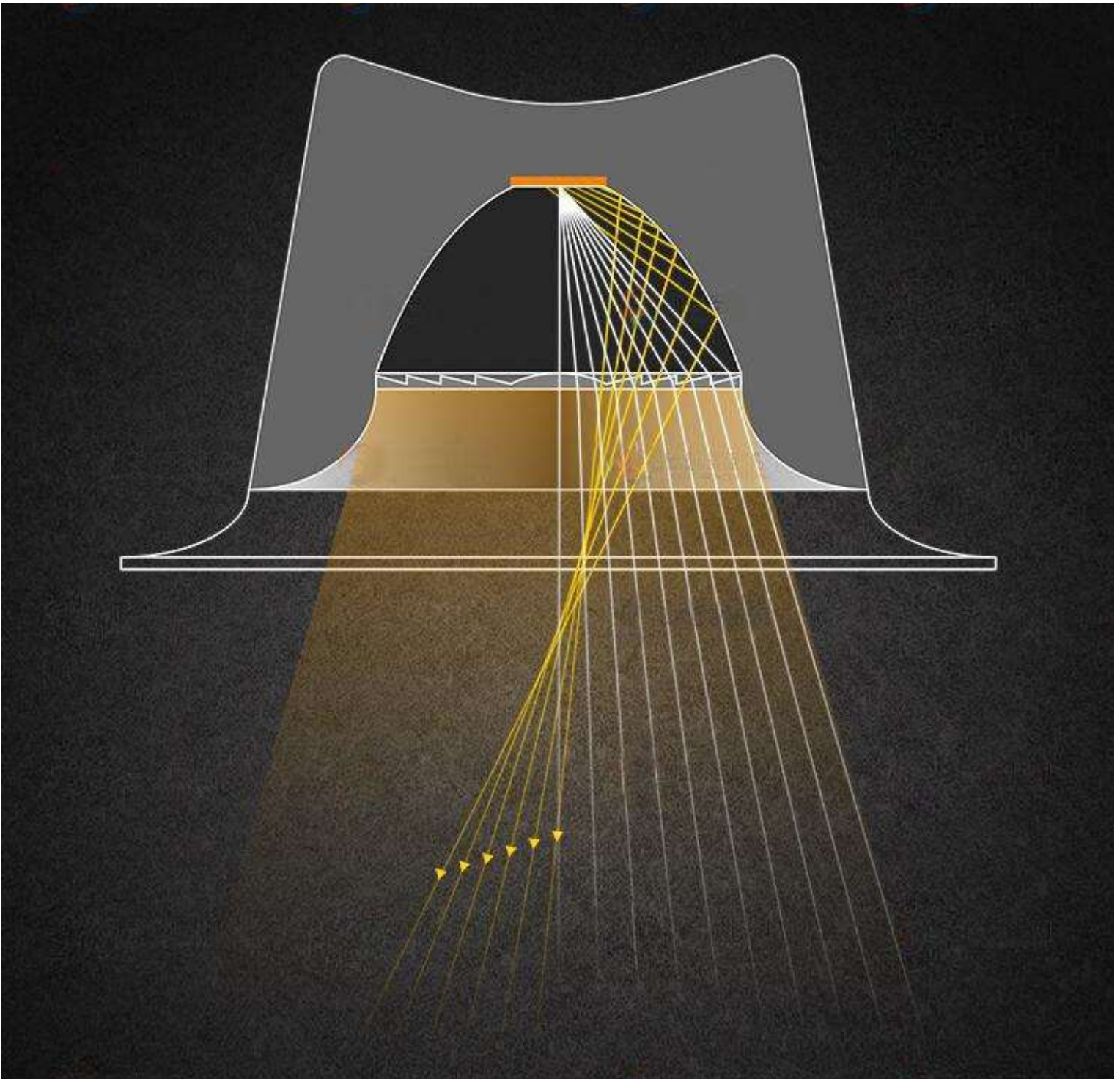

- Reliable material: die-casting Aluminum Not only guarantees corrosion protection and rust prevention, but improves the heat dissipation efficiency
- Perfect illumination: Deep anti-glare design provide sufficient light for general lighting without glare ,bring a lozy and warm ambiance for your sight.
- Different reflectors: mirror reflector and frosted reflector for your option aiming at meet different request in the market .
- Large wattage: External Constant current isolated driver easily connected by male and female plugs, release the limit of wattage, high brightness in high ceiling also creates a cozy atmosphere for your Lobby.

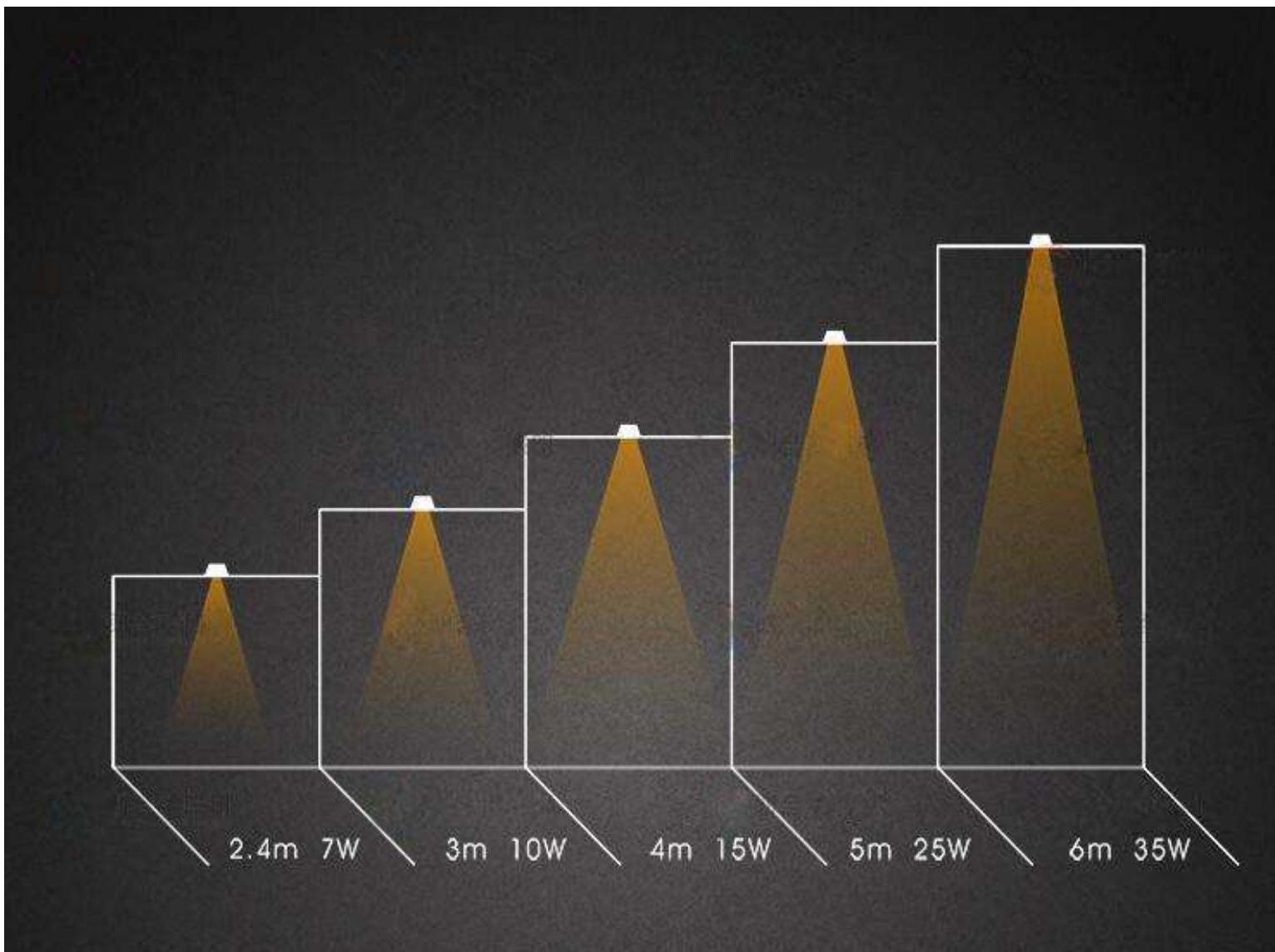



Power: 7W

Size:Φ90xH52mm

Cutout:Φ75mm

Power: 10W

Size:Φ115xH65mm

Cutout:Φ95mm

Power: 15W

Size:Φ140xH76mm

Cutout:Φ120mm

Power: 25W

Size:Φ200xH108mm

Cutout:Φ160mm

Power: 35W

Size:Φ230xH120mm

Cutout:Φ200mm

Model Code	DL07	DL10	DL15	DL25	DL35
Power	7W	10W	15W	25W	35W
Size:	Φ90*55mm	Φ115*65mm	Φ140*76mm	Φ200*108mm	Φ230*120mm
Cut out	Φ75mm	Φ95mm	Φ120mm	Φ160mm	Φ200mm
Light Source	Luminus / CREE	Luminus / CREE	Luminus / CREE	Luminus / CREE	Luminus / CREE
Optical	Len / Reflector	Len / Reflector	Len / Reflector	Len / Reflector	Len / Reflector
UGR	<19	<19	<19	<19	<19
Fliker<15%	√	√	√	√	√
Beam angle	60°/ 80°	60°/ 80°	60°/ 80°	60°/ 80°	60°/ 80°
CCT	3000K/4000K/6000K				
Power Factor	0.95	0.95	0.95	0.95	0.95
Efficiency	80%	80%	80%	80%	80%
Input Voltage	AC85-265V	AC85-265V	AC85-265V	AC85-265V	AC85-265V
Driver	Eaglerise /Lifud	Eaglerise /Lifud	Eaglerise /Lifud	Eaglerise /Lifud	Eaglerise /Lifud
IP	20	20	20	20	20
Material	Aluminium	Aluminium	Aluminium	Aluminium	Aluminium
Lifespan	50000h	50000h	50000h	50000h	50000h



Model Code	XE06	XE12	XE18	XE36	XE48
Power	6W	12W	18W	36W	48W
Size:	Φ90*H58mm	Φ102*H68mm	Φ140*H68mm	Φ180*H90mm	Φ230*H120mm
Cut out	Φ75mm	Φ90mm	Φ125mm	Φ150mm	Φ200mm
Light Source	SMD	SMD	SMD	SMD	SMD
Optical	Reflector	Reflector	Reflector	Reflector	Reflector
UGR	<19	<19	<19	<19	<19
Fliker<15%	√	√	√	√	√
Beam angle	80°	80°	80°	80°	80°
CCT	3000K/4000K/6000K				
Power Factor	0.95	0.95	0.95	0.95	0.95
Efficiency	80%	80%	80%	80%	80%
Input Voltage	AC85-265V	AC85-265V	AC85-265V	AC85-265V	AC85-265V
Driver	Eaglerise /Lifud	Eaglerise /Lifud	Eaglerise /Lifud	Eaglerise /Lifud	Eaglerise /Lifud
IP	20	20	20	20	20
Material	Aluminium	Aluminium	Aluminium	Aluminium	Aluminium
Lifespan	50000h	50000h	50000h	50000h	50000h



Model Code	T-110R	T-130R	T-165R	T-220R
Power	10W	15W	25W	35W
Size:	Φ110*H59mm	Φ127*H70mm	Φ164*H81mm	Φ220*H90mm
Cut out	Φ90mm	Φ110mm	Φ145mm	Φ200mm
Light Source	CREE	CREE	CREE	CREE
Optical	Reflector	Reflector	Reflector	Reflector
UGR	<22	<22	<22	<22
Fliker<15%	√	√	√	√
Beam angle	60°	60°	60°	60°
CCT	3000K/4000K/6000K			
Power Factor	0.95	0.95	0.95	0.95
Efficiency	80%	80%	80%	80%
Input Voltage	AC85-265V	AC85-265V	AC85-265V	AC85-265V
Driver	Eaglerise /Lifud	Eaglerise /Lifud	Eaglerise /Lifud	Eaglerise /Lifud
IP	65	65	65	65
Material	Aluminium	Aluminium	Aluminium	Aluminium
Lifespan	50000h	50000h	50000h	50000h



Model Code	T-110S	T-130S	T-165S	T-220S	
Power	10W	15W	25W	35W	
Size:	110*H59mm	127*H70mm	164*H81mm	220*H90mm	
Cut out	90mm	110mm	145mm	200mm	
Light Source	CREE	CREE	CREE	CREE	
Optical	Reflector	Reflector	Reflector	Reflector	
UGR	<22	<22	<22	<22	
Fliker<15%	√	√	√	√	
Beam angle	60°	60°	60°	60°	
CCT	3000K/4000K/6000K				
Power Factor	0.95	0.95	0.95	0.95	0.95
Efficiency	80%	80%	80%	80%	80%
Input Voltage	AC85-265V	AC85-265V	AC85-265V	AC85-265V	AC85-265V
Driver	Eaglerise /Lifud	Eaglerise /Lifud	Eaglerise /Lifud	Eaglerise /Lifud	Eaglerise /Lifud
IP	65	65	65	65	65
Material	Aluminium	Aluminium	Aluminium	Aluminium	Aluminium
Lifespan	50000h	50000h	50000h	50000h	50000h



Model Code	U15	U20	U30	U35
Power	15W	20W	30W	35W
Size:	Φ102*H68mm	Φ140*H68mm	Φ180*H90mm	Φ230*H120mm
Cut out	Φ90mm	Φ125mm	Φ150mm	Φ200mm
Light Source	Luminus / CREE	Luminus / CREE	Luminus / CREE	Luminus / CREE
Optical	Reflector	Reflector	Reflector	Reflector
UGR	<16	<16	<16	<16
Fliker<15%	√	√	√	√
Beam angle	24° / 36° / 60°	24° / 36° / 60°	24° / 36° / 60°	24° / 36° / 60°
CCT				
Power Factor	0.95	0.95	0.95	0.95
Efficiency	80%	80%	80%	80%
Input Voltage	AC85-265V	AC85-265V	AC85-265V	AC85-265V
Driver	Eaglerise /Lifud	Eaglerise /Lifud	Eaglerise /Lifud	Eaglerise /Lifud
IP	20	20	20	20
Material	Aluminium	Aluminium	Aluminium	Aluminium
Lifespan	50000h	50000h	50000h	50000h

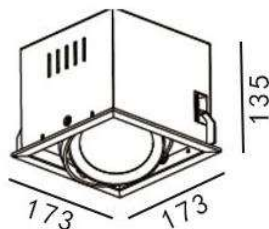
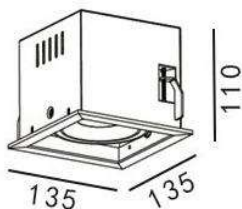
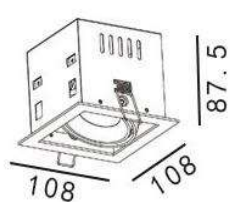

Model Code	AR07	AR15	AR25
Power	7W	15W	25W
Size:	108*108*87.5mm	135*135*110mm	173*173*135mm
Cut out			
Light Source	CREE / LUMINUS	CREE / LUMINUS	CREE / LUMINUS
Optical	Reflector	Reflector	Reflector
UGR	<25	<25	<25
Fliker<15%	√	√	√
Beam angle	18°/24° / 36°	18°/24° / 36°	18°/24° / 36°
CCT	3000K/4000K/6000K		
Power Factor	0.95	0.95	0.95
Efficiency	80%	80%	80%
Input Voltage	AC85-265V	AC85-265V	AC85-265V
Driver	Eaglerise /Lifud	Eaglerise /Lifud	Eaglerise /Lifud
IP	20	20	20
Material	Aluminium	Aluminium	Aluminium
Lifespan	50000h	50000h	50000h

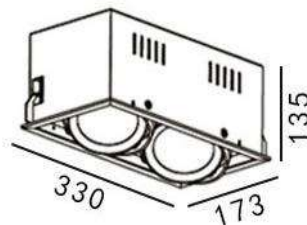
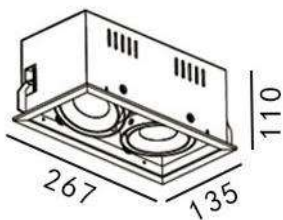
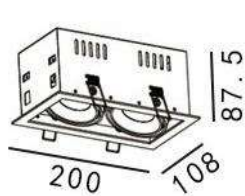

Model Code	AR07-2	AR15-2	AR25-2
Power	7X2W	15X2W	25X2W
Size:	200*108*87.5mm	267*135*110mm	330*173*135mm
Cut out	185*105mm	255*125mm	315*160mm
Light Source	CREE / LUMINUS	CREE / LUMINUS	CREE / LUMINUS
Optical	Reflector	Reflector	Reflector
UGR	<25	<25	<25
Fliker<15%	√	√	√
Beam angle	18°/24° / 36°	18°/24° / 36°	18°/24° / 36°
CCT	3000K/4000K/6000K		
Power Factor	0.95	0.95	0.95
Efficiency	80%	80%	80%
Input Voltage	AC85-265V	AC85-265V	AC85-265V
Driver	Eaglerise /Lifud	Eaglerise /Lifud	Eaglerise /Lifud
IP	20	20	20
Material	Aluminium	Aluminium	Aluminium
Lifespan	50000h	50000h	50000h

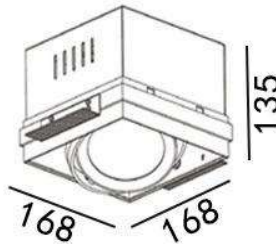
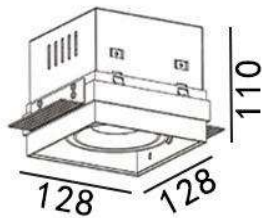
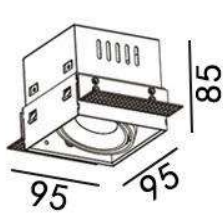

Model Code	HR07	HR15	HR25
Power	7W	15W	25W
Size:	95*95*85mm	128*128*110mm	168*168*135mm
Cut out			
Light Source	CREE / LUMINUS	CREE / LUMINUS	CREE / LUMINUS
Optical	Reflector	Reflector	Reflector
UGR	<25	<25	<25
Fliker<15%	√	√	√
Beam angle	18°/24° / 36°	18°/24° / 36°	18°/24° / 36°
CCT	3000K/4000K/6000K		
Power Factor	0.95	0.95	0.95
Efficiency	80%	80%	80%
Input Voltage	AC85-265V	AC85-265V	AC85-265V
Driver	Eaglerise /Lifud	Eaglerise /Lifud	Eaglerise /Lifud
IP	20	20	20
Material	Aluminium	Aluminium	Aluminium
Lifespan	50000h	50000h	50000h

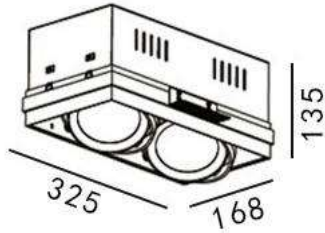
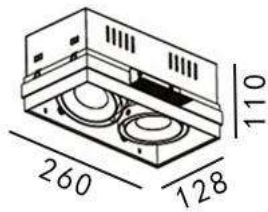
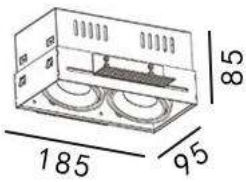

Model Code	HR07-2	HR15-2	HR25-2
Power	7X2W	15X2W	25X2W
Size:	185*95*85mm	260*128*110mm	325*168*135mm
Cut out			
Light Source	CREE / LUMINUS	CREE / LUMINUS	CREE / LUMINUS
Optical	Reflector	Reflector	Reflector
UGR	<25	<25	<25
Fliker<15%	√	√	√
Beam angle	18°/24° / 36°	18°/24° / 36°	18°/24° / 36°
CCT	3000K/4000K/6000K		
Power Factor	0.95	0.95	0.95
Efficiency	80%	80%	80%
Input Voltage	AC85-265V	AC85-265V	AC85-265V
Driver	Eaglerise /Lifud	Eaglerise /Lifud	Eaglerise /Lifud
IP	20	20	20
Material	Aluminium	Aluminium	Aluminium
Lifespan	50000h	50000h	50000h



Model Code	LY10	LY18	LY30	LY40
Power	10W	18W	30W	40W
Size:	Φ90*H76mm	Φ108*H96mm	Φ138*H129mm	Φ165*H129mm
Cut out	Φ85mm	Φ95mm	Φ125mm	Φ150mm
Light Source	Luminus / CREE	Luminus / CREE	Luminus / CREE	Luminus / CREE
Optical	Reflector	Reflector	Reflector	Reflector
UGR	<19	<19	<19	<19
Fliker<15%	√	√	√	√
Beam angle	15°/ 30°/45°	15°/ 30°/45°	15°/ 30°/45°	15°/ 30°/45°
CCT	3000K/4000K/6000K			
Power Factor	0.95	0.95	0.95	0.95
Efficiency	80%	80%	80%	80%
Input Voltage	AC85-265V	AC85-265V	AC85-265V	AC85-265V
Driver	Eaglerise /Lifud	Eaglerise /Lifud	Eaglerise /Lifud	Eaglerise /Lifud
IP	20	20	20	20
Material	Aluminium	Aluminium	Aluminium	Aluminium
Lifespan	50000h	50000h	50000h	50000h



Model Code	HH05	HH10	HH15
Power	10W	20W	30W
Size:	136.5*34*70mm	269*34*70mm	402*34*70mm
Cut out	Surface Mounted	Surface Mounted	Surface Mounted
Light Source	CREE /OSRAM	CREE /OSRAM	CREE /OSRAM
Optical	Reflector	Reflector	Reflector
UGR	<25	<25	<25
Fliker<15%	√	√	√
Beam angle	15°/ 30°/45°	15°/ 30°/45°	15°/ 30°/45°
CCT	3000K/4000K/6000K		
Power Factor	0.95	0.95	0.95
Efficiency	80%	80%	80%
Input Voltage	AC85-265V	AC85-265V	AC85-265V
Driver	Eaglerise /Lifud	Eaglerise /Lifud	Eaglerise /Lifud
IP	20	20	20
Material	Aluminium	Aluminium	Aluminium
Lifespan	50000h	50000h	50000h



Model Code	BH-01	BH-02	BH-05	BH-10	BH-15
Power	2W	4W	10W	20W	30W
Size:	35*35*50mm	70*35*50mm	140*35*50mm	275*35*50mm	405*35*50mm
Cut out	35*35mm	70*35mm	140*35mm	275*35mm	405*35mm
Light Source	CREE /OSRAM	CREE /OSRAM	CREE /OSRAM	CREE /OSRAM	CREE /OSRAM
Optical	Reflector	Reflector	Reflector	Reflector	Reflector
UGR	<25	<25	<25	<25	<25
Fliker<15%	√	√	√	√	√
Beam angle	15°/ 30°/45°	15°/ 30°/45°	15°/ 30°/45°	15°/ 30°/45°	15°/ 30°/45°
CCT	3000K/4000K/6000K				
Power Factor	0.95	0.95	0.95	0.95	0.95
Efficiency	80%	80%	80%	80%	80%
Input Voltage	AC85-265V	AC85-265V	AC85-265V	AC85-265V	AC85-265V
Driver	Eaglerise /Lifud	Eaglerise /Lifud	Eaglerise /Lifud	Eaglerise /Lifud	Eaglerise /Lifud
IP	20	20	20	20	20
Material	Aluminium	Aluminium	Aluminium	Aluminium	Aluminium
Lifespan	50000h	50000h	50000h	50000h	50000h



Model Code	HL-01	HL-02	HL-05	HL-10	HL-15
Power	2W	4W	10W	20W	30W
Size:	45*45*50mm	75*45*50mm	145*45*50mm	280*45*50mm	410*45*50mm
Cut out	35*35mm	65*35mm	135*35mm	270*35mm	400*35mm
Light Source	CREE /OSRAM	CREE /OSRAM	CREE /OSRAM	CREE /OSRAM	CREE /OSRAM
Optical	Reflector	Reflector	Reflector	Reflector	Reflector
UGR	<25	<25	<25	<25	<25
Fliker<15%	√	√	√	√	√
Beam angle	15°/ 30°/45°	15°/ 30°/45°	15°/ 30°/45°	15°/ 30°/45°	15°/ 30°/45°
CCT	3000K/4000K/6000K				
Power Factor	0.95	0.95	0.95	0.95	0.95
Efficiency	80%	80%	80%	80%	80%
Input Voltage	AC85-265V	AC85-265V	AC85-265V	AC85-265V	AC85-265V
Driver	Eaglerise /Lifud	Eaglerise /Lifud	Eaglerise /Lifud	Eaglerise /Lifud	Eaglerise /Lifud
IP	20	20	20	20	20
Material	Aluminium	Aluminium	Aluminium	Aluminium	Aluminium
Lifespan	50000h	50000h	50000h	50000h	50000h



Model Code	XT-10	XT-20	XT-30
Power	10W	20W	30W
Size:	147*45*50mm	279*45*50mm	411*45*50mm
Cut out	139*37mm	272*45mm	403*37mm
Light Source	CREE /OSRAM	CREE /OSRAM	CREE /OSRAM
Optical	Reflector	Reflector	Reflector
UGR	<25	<25	<25
Fliker<15%	√	√	√
Beam angle	30°	30°	30°
CCT	3000K/4000K/6000K		
Power Factor	0.95	0.95	0.95
Efficiency	80%	80%	80%
Input Voltage	AC85-265V	AC85-265V	AC85-265V
Driver	Eaglerise /Lifud	Eaglerise /Lifud	Eaglerise /Lifud
IP	20	20	20
Material	Aluminium	Aluminium	Aluminium
Lifespan	50000h	50000h	50000h

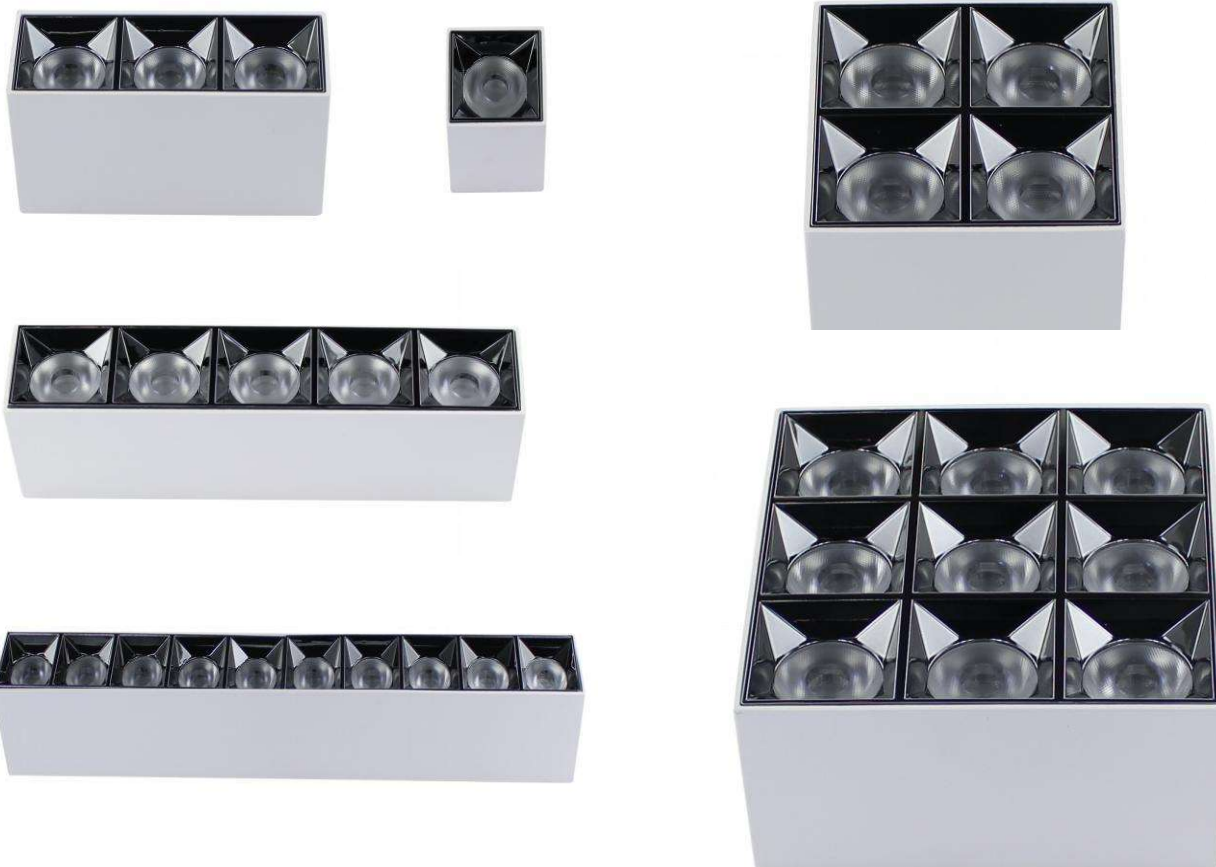

Model Code	JG-03W	JG-09W	JG-12W	JG-15W	JG-27W	JG-30W
Power	3W	9W	12W	15W	27W	30W
Size:	42*42*55mm	42*119*55mm	80*80*55mm	42*195*55mm	118*118*55mm	42*383*55mm
Installation	Surface mounted					
Light Source	CREE /OSRAM	CREE /OSRAM	CREE /OSRAM	CREE /OSRAM	CREE /OSRAM	CREE /OSRAM
Optical	Reflector	Reflector	Reflector	Reflector	Reflector	Reflector
UGR	<22	<22	<22	<22	<22	<22
No Flicker	√	√	√	√	√	√
Beam angle	12° / 15° / 25° / 55° / 75° / 35*35° / 35*75° / 55*55° / 75*75°					
CCT	3000K/4000K/6000K					
Power Factor	0.95	0.95	0.95	0.95	0.95	0.95
Efficiency	80%	80%	80%	80%	80%	80%
Input Voltage	AC85-265V	AC85-265V	AC85-265V	AC85-265V	AC85-265V	AC85-265V
Driver	Eaglerise /Lifud	Eaglerise /Lifud	Eaglerise /Lifud	Eaglerise /Lifud	Eaglerise /Lifud	Eaglerise /Lifud
IP	20	20	20	20	20	20
Material	Aluminium	Aluminium	Aluminium	Aluminium	Aluminium	Aluminium
Lifespan	50000h	50000h	50000h	50000h	50000h	50000h



Model Code	RL-03W	RL-09W	RL-12W	RL-15W	RL-27W	RL-30W
Power	3W	9W	12W	15W	27W	30W
Size:	52*52*56mm	52*125*56mm	90*90*56mm	52*205*56mm	127*127*56mm	52*393*56mm
Installation	Recessed					
Light Source	CREE /OSRAM	CREE /OSRAM	CREE /OSRAM	CREE /OSRAM	CREE /OSRAM	CREE /OSRAM
Optical	Reflector	Reflector	Reflector	Reflector	Reflector	Reflector
UGR	<22	<22	<22	<22	<22	<22
No Flicker	√	√	√	√	√	√
Beam angle	12°/ 15° / 25°/ 55°/ 75°/ 35*35° / 35*75° / 55*55° / 75*75°					
CCT	3000K/4000K/6000K					
Power Factor	0.95	0.95	0.95	0.95	0.95	0.95
Efficiency	80%	80%	80%	80%	80%	80%
Input Voltage	AC85-265V	AC85-265V	AC85-265V	AC85-265V	AC85-265V	AC85-265V
Driver	Eaglerise /Lifud	Eaglerise /Lifud	Eaglerise /Lifud	Eaglerise /Lifud	Eaglerise /Lifud	Eaglerise /Lifud
IP	20	20	20	20	20	20
Material	Aluminium	Aluminium	Aluminium	Aluminium	Aluminium	Aluminium
Lifespan	50000h	50000h	50000h	50000h	50000h	50000h

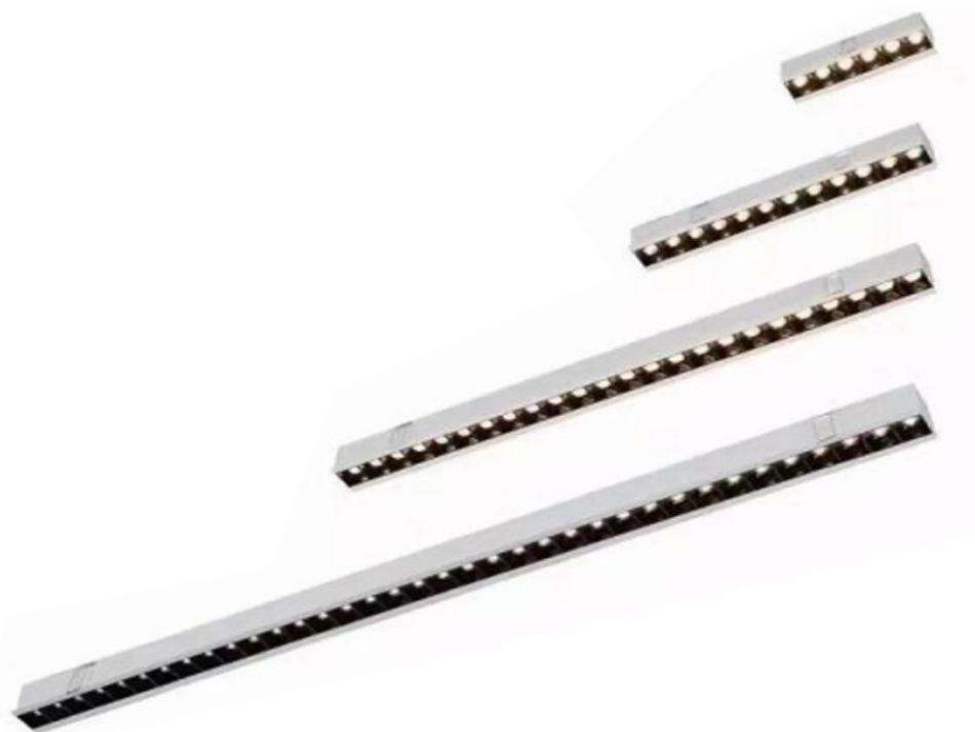

Model Code	MH20	MH40	MH45
Power	20W	40W	45W
Size:	544*42*50mm	1077*42*50mm	1209*42*50mm
Installation	RECESSED	RECESSED	RECESSED
Light Source	OSRAM 3030	OSRAM 3030	OSRAM 3030
Optical	Reflector	Reflector	Reflector
UGR	<22	<22	<22
No Flicker	√	√	√
Beam angle	9°/15°/ 30°/45°	9°/15°/ 30°/45°	9°/15°/ 30°/45°
CCT			
Power Factor	0.95	0.95	0.95
Efficiency	80%	80%	80%
Input Voltage	AC85-265V	AC85-265V	AC85-265V
Driver	Eaglerise /Lifud	Eaglerise /Lifud	Eaglerise /Lifud
IP	20	20	20
Material	Aluminium	Aluminium	Aluminium
Lifespan	50000h	50000h	50000h



Model Code	HH30	HH40	HH45	HH45B
Power	30W	40W	45W	45W
Size:	800*33*60mm	1065*33*60mm	1200*33*60mm	1200*33*85mm
Installation	Surface / Hanging	Surface / Hanging	Surface / Hanging	Surface / Hanging
Light Source	OSRAM 3030	OSRAM 3030	OSRAM 3030	OSRAM 3030
Optical	Reflector	Reflector	Reflector	Reflector
UGR	<22	<22	<22	<22
No Flicker	√	√	√	√
Beam angle	9°/15°/ 30°/45°	9°/15°/ 30°/45°	9°/15°/ 30°/45°	9°/15°/ 30°/45°
CCT	2700-6500K	2700-6500K	2700-6500K	2700-6500K
Power Factor	0.95	0.95	0.95	0.95
Efficiency	80%	80%	80%	80%
Input Voltage	AC85-265V	AC85-265V	AC85-265V	AC85-265V
Driver	Eaglerise /Lifud	Eaglerise /Lifud	Eaglerise /Lifud	Eaglerise /Lifud
IP	20	20	20	20
Material	Aluminium	Aluminium	Aluminium	Aluminium
Lifespan	50000h	50000h	50000h	50000h





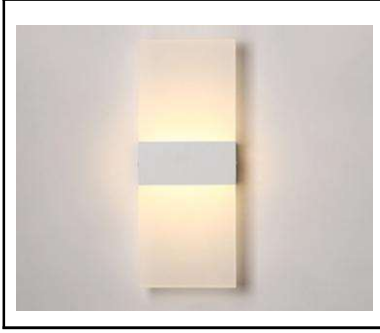

Item No.:201 WH
Size:290*110*50mm
IP:20

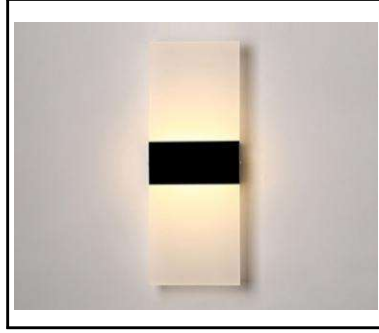

Item No.:201 BK
Size:290*110*50mm
IP:20

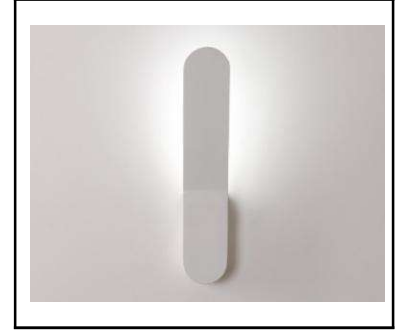

Item No.: 202 WH
Size:320*60*85mm
IP:20

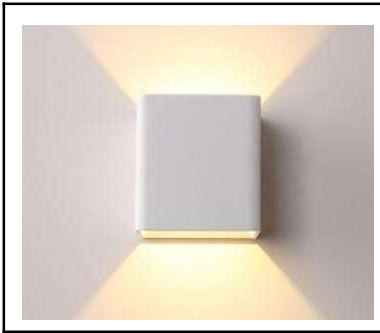

Item No.:203 WH
Size:100*100*100mm
IP:20



Item No.:203 BK
Size:100*100*100mm
IP:20



Item No.:202 BK
Size:320*60*85mm
IP:20



Item No.:204
Size:260*200*80mm
IP:20



Item No.:205
Size:240*200*80mm
IP:20



Item No.:206
Size:430*120*120
IP:20

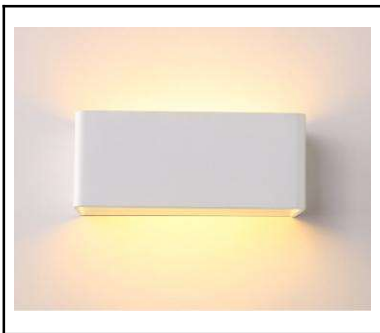

Item No.:207 WH
Size:200*100*100mm
IP:20



Item No.:207 BK
Size:200*100*100mm
IP:20



Item No.:208
Size:300*50mm
IP:20



Item No.:901 WH
Size:Φ140*70mm
IP:20



Item No.:901 BK
Size:Φ140*70mm
IP:20



Item No.:902
Size:250*100*100mm
IP:20

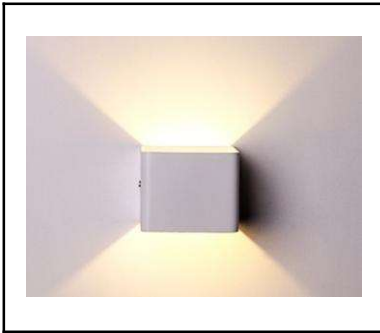

Item No.: 903 WH
Size:100*100mm
IP:20

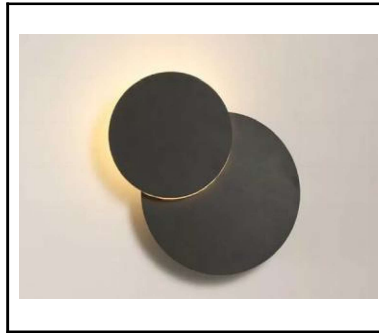

Item No.:904 BK
Size:Φ180*53mm
IP:20

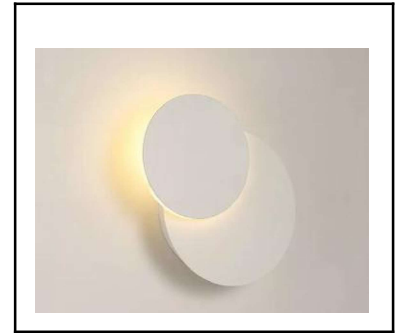

Item No.:904 WH
Size:Φ180*53mm
IP:20

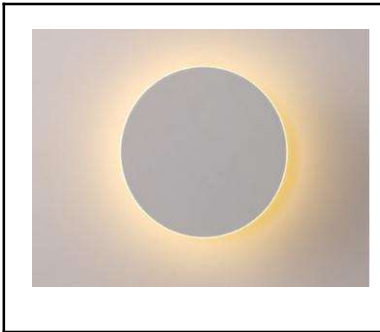

Item No.:905 WH
Size:Φ180mm
IP:20



Item No.:906
Size:Φ135*340mm
IP:20

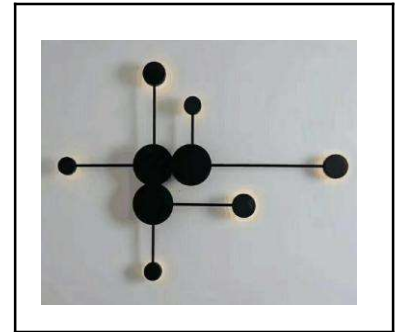

Item No.:910
Size:
IP:20

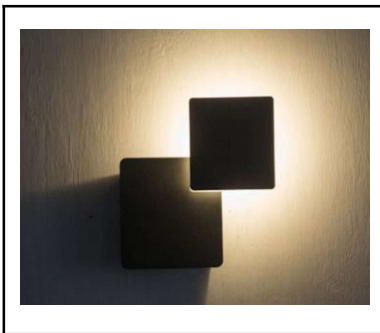

Item No.:907 BK
Size:180*180mm
IP:20



Item No.:907 WH
Size:180*180mm
IP:20

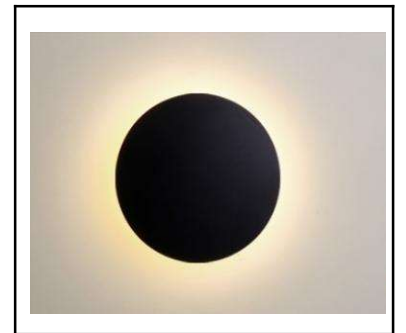

Item No.:905 BK
Size:Φ180mm
IP:20



ITEM NO.:	921-45 / 921-60
Material:	Steel + acylic
size:	450 / 600 mm
Light source:	SMD LED
Application	Hotel , shop , Home decoration



ITEM NO.:	923-2 / 923-3 / 923-6
Material:	Aluminum+ acylic
size:	420x300x70mm / 550x360x70mm / 740x740x70mm
Light source:	SMD LED
Application	Hotel , shop , Home decoration



ITEM NO.:	931...
Material:	Aluminum
size:	300x65mm
Light source:	SMD LED
Application	Hotel , shop , Home decoration



ITEM NO.:	905-200 / 905-250
Material:	Aluminum
size:	Φ200 / 250mm
Light source:	SMD LED
Application	Hotel , shop , Home decoration
IP Rating	IP 20 / IP65

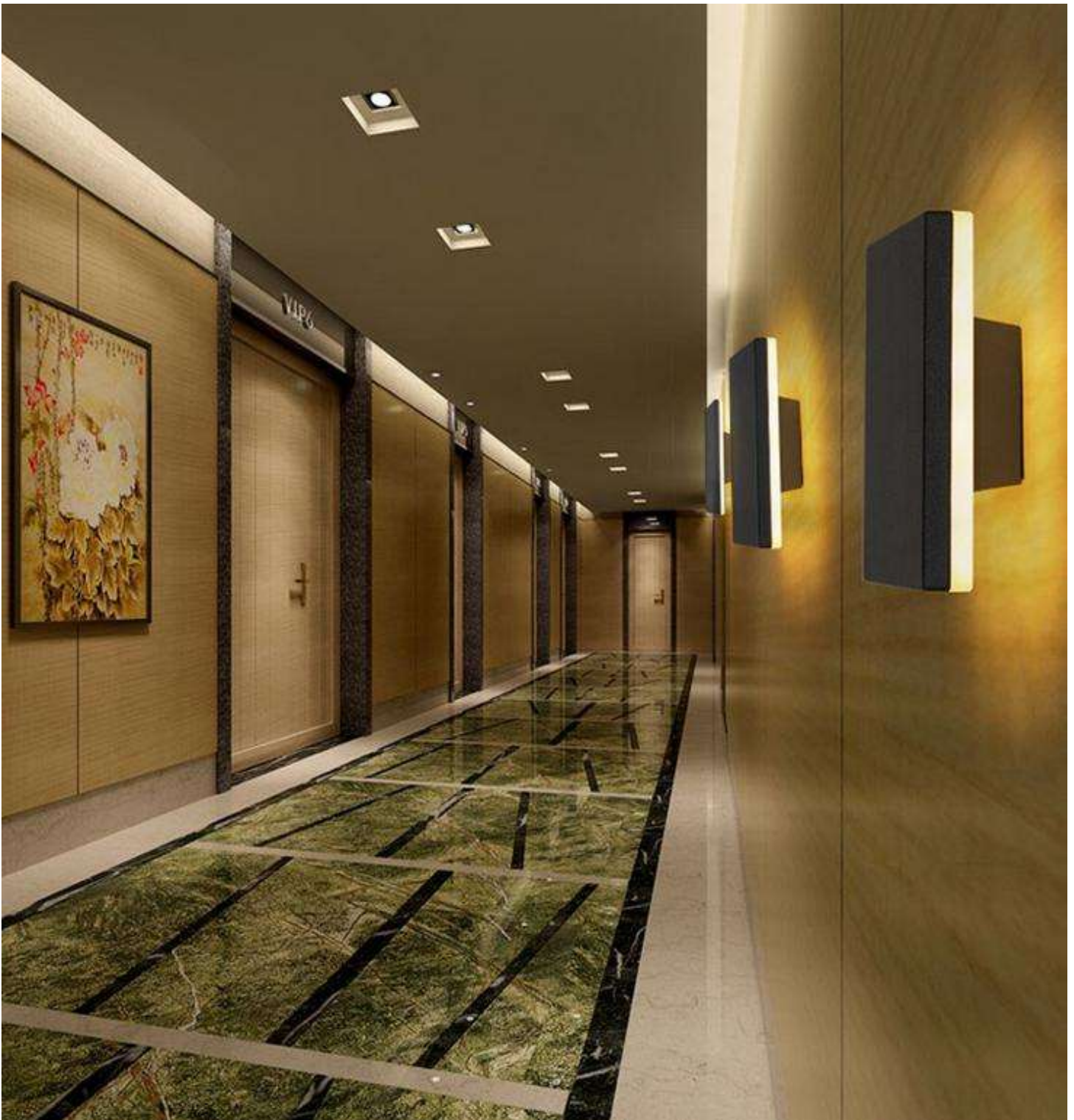

ITEM NO.:	932-200 / 932-250
Material:	Aluminum
size:	200*200*65 / 250*250*65mm
Light source:	SMD LED
Application	Hotel , shop , Home decoration
IP Rating	IP 20 / IP65

www.caprazze.com



ITEM NO.:	924..
Material:	Aluminum
size:	Φ250x50mm
Light source:	SMD LED
Application	Hotel , shop , Home decoration
IP Rating	IP 20

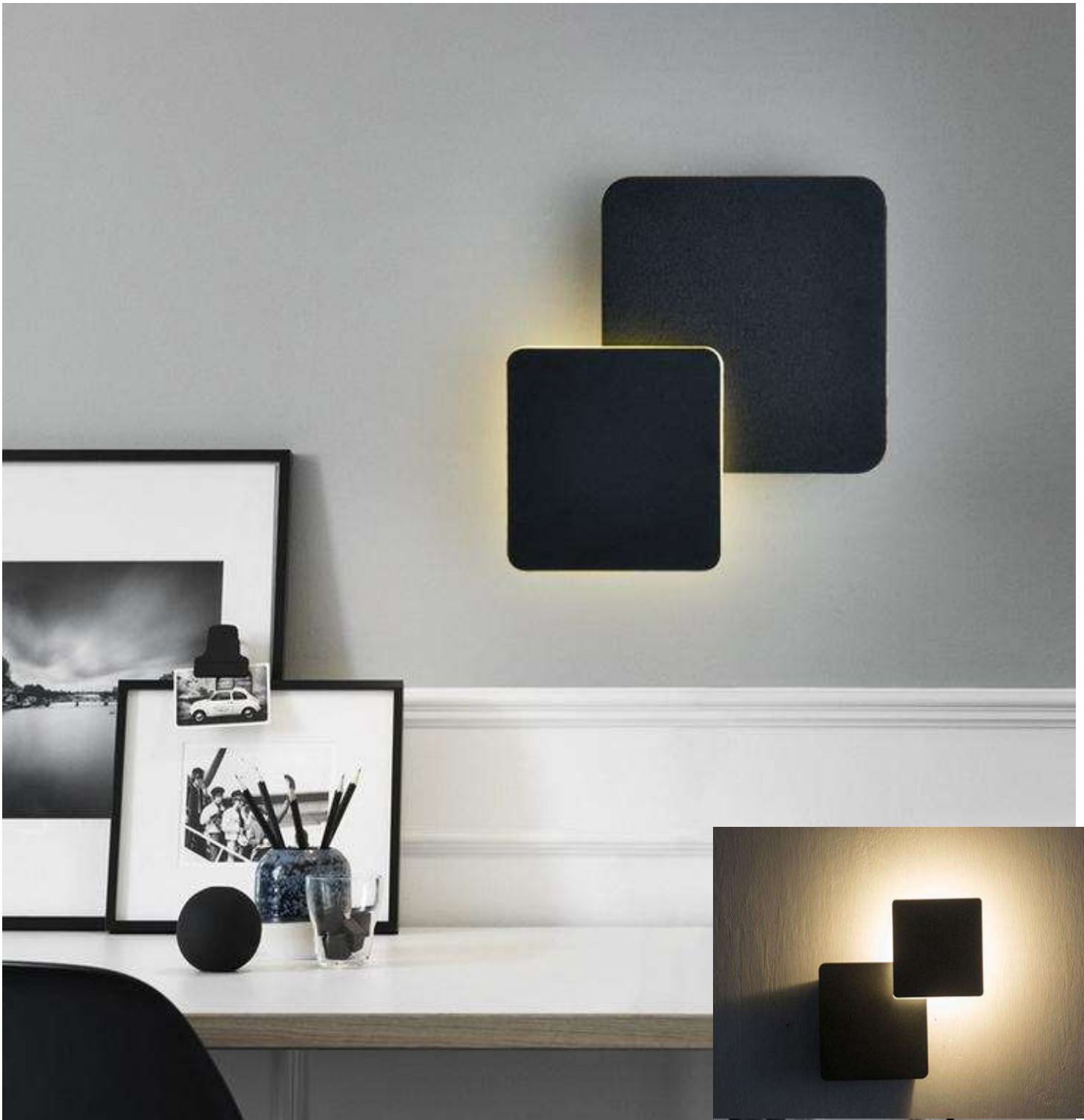

ITEM NO.:	907..
Material:	Aluminum
size:	250x250x50mm
Light source:	SMD LED
Application	Hotel , shop , Home decoration
IP Rating	IP 20



ITEM NO.:	925RD
Material:	Aluminum
size:	Φ140*70 mm
Light source:	SMD LED
Application	Hotel , shop , Home decoration
IP Rating	IP 20 / IP65



ITEM NO.:	925SQ
Material:	Aluminum
size:	140*140*70 mm
Light source:	SMD LED
Application	Hotel , shop , Home decoration
IP Rating	IP 20 / IP65



ITEM NO.:	927..
Material:	Aluminum
size:	70*350*65 mm
Light source:	SMD LED
Application	Hotel , shop , Home decoration
IP Rating	IP 20



ITEM NO.:	606..
Material:	Aluminum
size:	250x250x50mm
Light source:	SMD LED
Application	Hotel , shop , Home decoration
IP Rating	IP 20 / IP65

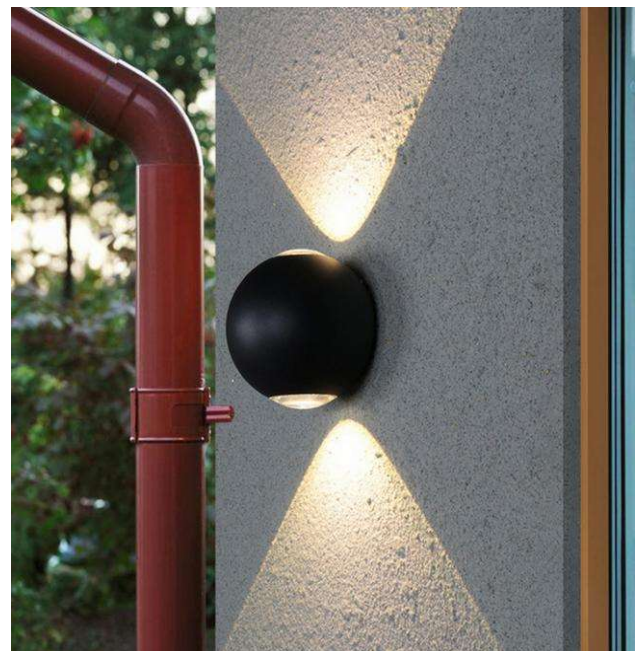
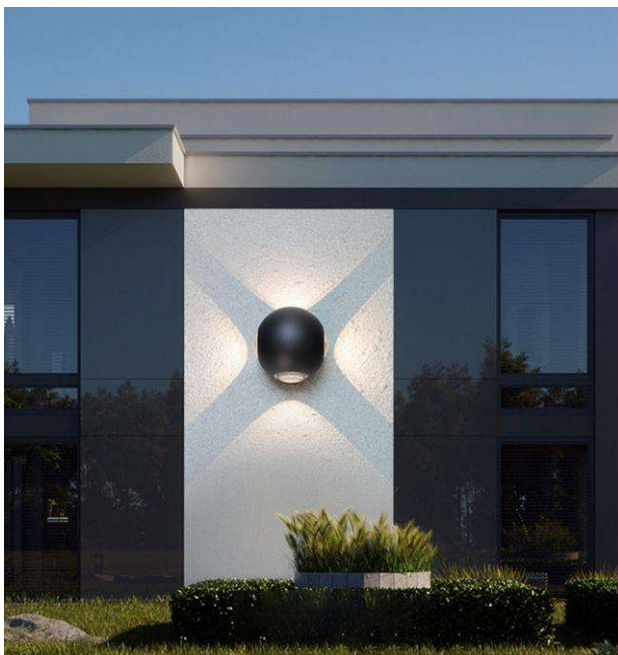
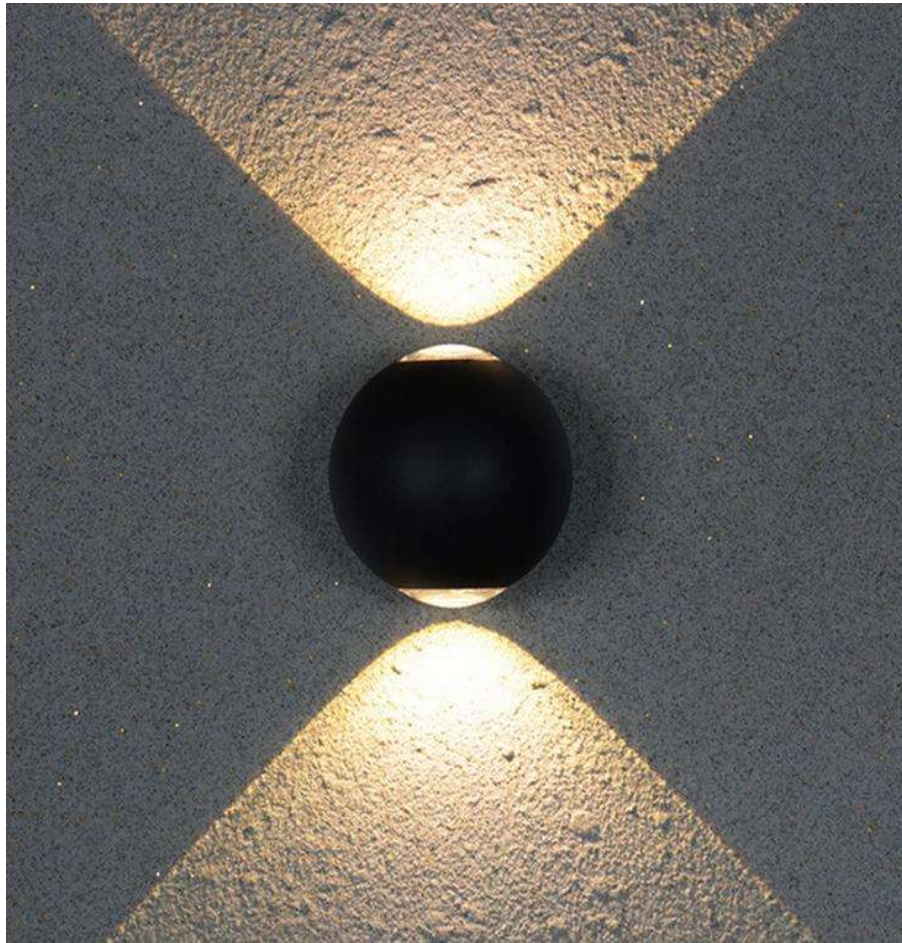

ITEM NO.:	604-2 / 604-4
Material:	Aluminum
size:	Φ110*H60mm
Light source:	COB LED
Application	Hotel , shop , Home decoration
IP Rating	IP65

www.caprazze.com



ITEM NO.:	601..
Material:	Aluminum
size:	Φ120*65mm
Light source:	SMD LED
Application	Hotel , shop , Home decoration
IP Rating	IP65



ITEM NO.:	602..
Material:	Aluminum
size:	120*120*65mm
Light source:	SMD LED
Application	Hotel , shop , Home decoration
IP Rating	IP65



ITEM NO.:	607..
Material:	Aluminum
size:	100*100*100mm
Light source:	SMD LED
Application	Hotel , shop , Home decoration
IP Rating	IP65



ITEM NO.:	207-150 / 207-250 / 207-350
Material:	Aluminum
size:	150*60*100mm / 250*60*100mm / 350*60*100mm
Light source:	SMD LED
Application	Hotel , shop , Home decoration
IP Rating	IP65



ITEM NO.:	201..
Material:	Aluminum + Acylic
size:	290*110*50mm
Light source:	SMD LED
Application	Hotel , shop , Home decoration
IP Rating	IP20



ITEM NO.:	209..
Material:	Aluminum + Acylic
size:	80*280*125mm
Light source:	COB LED
Application	Hotel , shop , Home decoration
IP Rating	IP20



ITEM NO.:	209..
Material:	Aluminum + Acylic
size:	80*280*125mm
Light source:	COB LED
Application	Hotel , shop , Home decoration
IP Rating	IP20

www.caprazze.com





Item No.:601
Size:Φ160mm
IP:65



Item No.:602
Size:160*160*190mm
IP:65



Item No.:603
Size:260*120mm
IP:65



Item No.:604 WH
Size:Φ100mm
IP:65

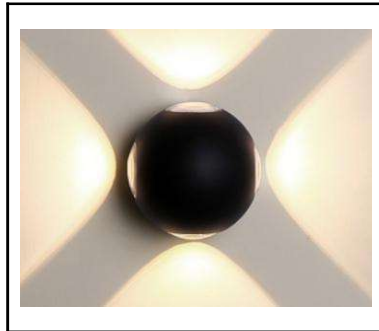

Item No.:604 BK
Size:Φ100mm
IP:65



Item No.:605 WH
Size:200*90*90mm
IP:65



Item No.:606 BK
Size Size:100*100*100mm
IP:65

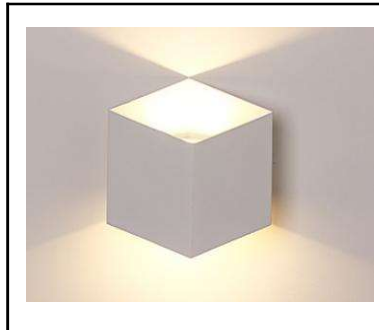

Item No.:606 WH
Size:100*100*100mm
IP:65



Item No.:605 BK
Size:200*90*90mm
IP:65

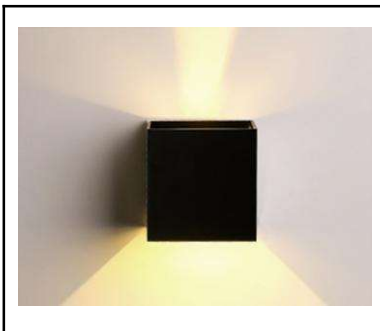

Item No.:607 BK
Size:100*100*100mm
IP:65

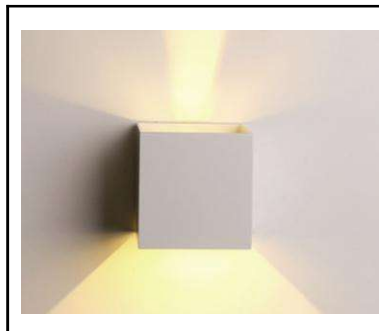

Item No.:607 WH
Size:100*100*100mm
IP:65

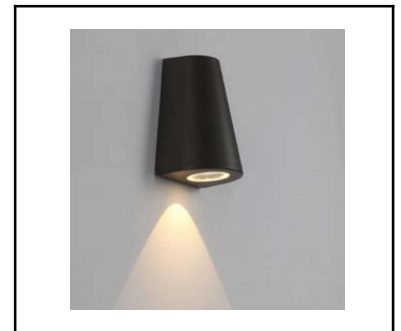

Item No.:608
Size:150*200mm
IP:65



Item No.:S-015
Size:Φ50*47mm
Power: 3W , IP:20



Item No.:S-016
Size: Φ50*47mm
Power: 3W , IP:20



Item No.:S-017
Size:Φ50*47mm
Power: 3W , IP:20



Item No.:S-018
Size:Φ50*45mm
Power: 3W , IP:20



Item No.:T-019
Size:50*50*44mm
Power: 2W , IP:20



Item No.:H-H03
Size:Φ60*H85mm
Power: 5W , IP:20



Item No.:T-012
Size:Φ44*43mm
Power: 3W , IP:20



Item No.:R-09WH
Size: Φ48,5*31,5mm
Power: 3W , IP:20



Item No.:R-12B
Size: Φ44*32,5mm
Power: 3W , IP:20



Item No.:S-S09
Size:45*45*28.5mm
Power: 3W , IP:20



Item No.:Φ50*55mm
Size:100*100*100mm
Power: 2.5W , IP:20



Item No.:GF-05
Size:Φ60*50mm
Power: 5W , IP:20

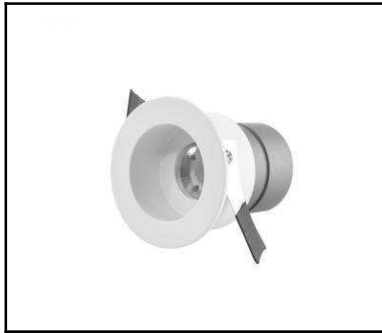

Item No.:M201
Size:Φ40mm
Power: 3W , IP:20



Item No.:M202
Size:Φ40mm
Power: 3W , IP:20



Item No.:M203
Size:Φ40mm
Power: 3W , IP:20



Item No.:EK-M03
Size:Φ38*35mm
Power: 1W , IP:20



Item No.:GH-03
Size:Φ 50*35mm
Power: 3W , IP:20



Item No.:GH-05
Size:Φ50*50mm
Power: 3W , IP:20

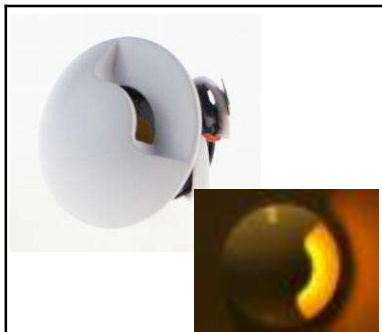

Item No.:T-T001
Size:Φ51.5*43mm
Power: 3W , IP:20



Item No.:T-T002
Size:1 Φ51.5*43mm
Power: 3W , IP:20



Item No.:CN-A01
Size:Φ38*H11mm
Power: 1W , IP:20



Item No.:CN-L03
Size:Φ69*H14mm
Power: 3W , IP:20



Item No.:607 WH
Size:100*100*100mm
Power: 3W , IP:20



Item No.:CN-A03
Size:Φ69*H14mm
Power: 3W , IP:20



Item No.:B07
Size:Φ54*70mm
Power: 7W



Item No.:B12
Size:Φ59*86mm
Power: 12W



Item No.:C10
Size:Φ48*80mm
Power: 9W



Item No.:D12
Size:Φ61*85mm
Power: 12W



Item No.:1822
Size: Φ91mm
Fix : Led Mould , MR 16, GU 10



Item No.:1824
Size:84*75mm
Fix : Led Mould , MR 16, GU 10



Item No.:1830
Size: Φ80mm
Fix : Led Mould , MR 16, GU 10



Item No.:1833
Size: Φ80mm
Fix : Led Mould , MR 16, GU 10



Item No.:1834
Size:Φ80mm
Fix : Led Mould , MR 16, GU 10



Item No.:1837
Size:82*82mm
Fix : Led Mould , MR 16, GU 10



Item No.:1851
Size:Φ95mm
Fix : Led Mould , MR 16, GU 10



Item No.:1852
Size:95*95mm
Fix : Led Mould , MR 16, GU 10